



Order Code : 3099626
 Product Code : STL 016A 40OD00 1K4 120TK3I LN4XST

Product Data

Standard Features

Housing	: RAL 7047 Powder finished aluminium extrusion housing, aluminium injection cover
Diffuser	: Glare minimizing highly permeable diffuser
Ceiling Type	: Plasterboard
IP Grade	: IP40
Installation	: Recessed mounted
Light Source	: Mid Power LED

Optical & Electrical Features

Power Consumption	: 15.3 W
Final Luminous Flux	: 1582.0 lm
Efficacy	: 102.9 lm/W
Input Voltage	: 220-240 V AC
Frequency	: 50-60 Hz
Power Factor	: > 0,9
Surge Transient Protection	: 1 kV
Drive Current	: 400 mA
Correlated Color Temperature	: 4000K
Color Rendering Index	: >80

*There is ±%10 tolerance in the technical values.

Other Features & Conditions

Operating Temperature Range	: -25 °C/+40 °C
Operating Temperature Range With Emergency Kit	: +5 °C/+35 °C
Impact Resistance	: IK02
Led Life Time - L70	: > 72.000 hours @Ta= 40 °C

STL

15 W Recessed Mounted Single Module
 Linear LED Luminaire



Photometric Curve

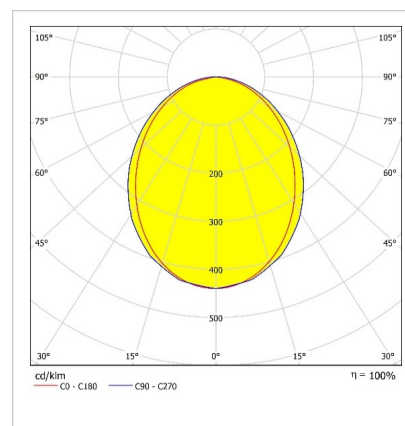

Optional Features

Correlated Color Temperatures	: 2700K, 3000K
Emergency Kit Options	: 1, 3 hours
DALI Option	: Yes
Color Option	: RAL 9005

STL

15 W Recessed Mounted Single Module Linear LED Luminaire

3099626 STL 016A 40OD00 1K4 120TK3I LN4XST

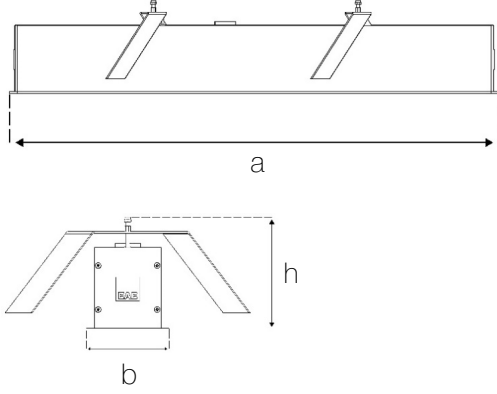

Dimensions (mm)

	a	b	h	d ¹ , d ²
Single Module	1224	86	120	1215x79
Starting Module	1211	86	120	1208x79
Finishing Module	1211	86	120	1208x79
Intermediate Module	1201	86	120	1201x79
Horizontal Rotation	647.5	86	120	630x79
Vertical Rotation	656	86	120	571x79

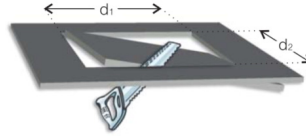

Weight (kg)

Standard	3,9
Horizontal-Vertical Rotation	4
With Emergency Kit (1 hr.)	4,3
With Emergency Kit (3 hrs.)	4,3

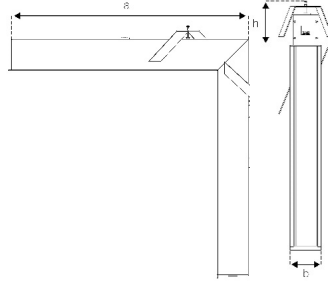

Vertical Rotation

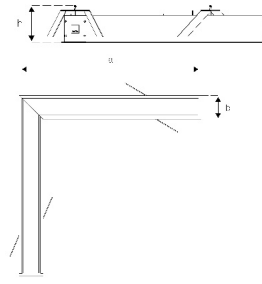

Horizontal Rotation



Installation System

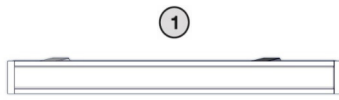

Single (TK)

1

Ordering Code : 3099626
Product Code : STL 016A 40OD00 1K4
120TK3I LN4XST
Module Model : Single (TK)

2

Ordering Code : 3099624
Product Code : STL 016A 40OD00 1K4
120BS3I LN4XST
Module Model : Starting (BS)

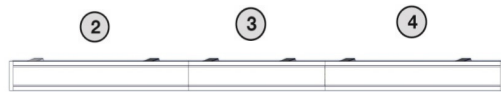

Starting (BS) Intermediate (AR) Finishing (SN)

3

Ordering Code : 3099623
Product Code : STL 016A 40OD00 1K4
120AR3I LN4XST
Module Model : Intermediate (AR)

4

Ordering Code : 3099625
Product Code : STL 016A 40OD00 1K4
120SN3I LN4XST
Module Model : Finishing (SN)



Starting (BS) Finishing (SN)

- EAE, reserves the right to make changes without prior notice.



Revision date: 09.02.2020