

E-LINE INFO

CABLE TRAY SYSTEMS



Technical Information
Certificates
General Product Specifications
Weight Carriage Figures

INFO

www.eaeelectric.com



CONTENTS

2-13	Technical Specification
14-15	Certificates
16	System Functionality in Case of Fire
17	UKFE Cable Tray Product Overview
18	UKS Cable Tray Product Overview
19	UKFG Universal Cable Tray Overview
20	UKF-C Universal Cable Tray Overview
21	UMK Cable Ladder Product Overview
22	KM Cable Ladder Product Overview
23	TKS Cable Tray Product Overview
24	CTHF-E Cable Tray Product Overview
25	CTH-CTA Cable Tray Product Overview
	KMH-KMA Cable Ladder Product Overview
26	Cable Baskets Product Overview
27	Packaging

▶▶ SELECTION OF CABLE SUPPORT SYSTEMS

The following method can be used to select the correct tray or ladder for the cable being used.

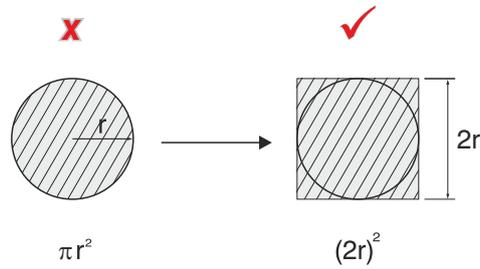

- 1- For the calculation of cross sectional area of the cable use $(2r)^2$ formula instead of πr^2
- 2- Find out the total cross-section by calculating all cables.
- 3- Select the leave 20% reserve for cable additions.
- 4- Select the appropriate cable support system from the following table.
- 5- Select the nearest large value to the total cross section while making the selection

UKS/UKD/UKF/UMK/ - CTHF/CTN/CTH/CTA/CTK Cable Trays

		Tray Height (mm)						
		40	50	60	75	100	125	150
Tray Width (mm)	50	2000	2500	-----	-----	-----	-----	-----
	100	4000	5000	6000	7500	10000	-----	-----
	150	6000	7500	9000	11250	15000	18750	-----
	200	8000	10000	12000	15000	20000	25000	30000
	250	10000	12500	15000	18750	25000	31250	37500
	300	12000	15000	18000	22500	30000	37500	45000
	400	16000	20000	24000	30000	40000	50000	60000
	500	20000	25000	30000	37500	50000	62750	75000
600	24000	30000	36000	45000	60000	75000	90000	

►► Cable Layout Table (Support distance 1,5 m)

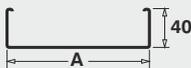
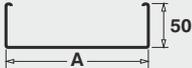
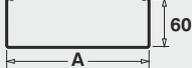
A	Values								
	Nominal Cross-section mm ²	Cable Outer Diameter mm	Net Weight (kg/m)	Quantity	Total Weight (kg/m)	Quantity	Total Weight (kg/m)	Quantity	Total Weight (kg/m)
50	4x1,5	13,0	0,250	8	2,000	12	3,000	12	3,000
	4x2,5	14,5	0,330	8	2,640	8	2,640	10	3,300
	4x4	16,5	0,435	6	2,610	6	2,610	9	3,915
	4x6	17,5	0,545	5	2,725	6	3,270	7	3,815
	4x10	19,5	0,745	3	2,235	3	2,235	5	3,725
	4x16	21,5	1,030	3	3,090	4	4,120	4	4,120
	4x25	27,5	1,610	1	1,610	2	3,220	2	3,220
	4x35	30,0	2,080	1	2,080	1	2,080	2	4,160
4x50	33,0	2,690	1	2,690	1	2,690	1	2,690	
100	4x1,5	13,0	0,250	21	5,250	28	7,000	33	8,250
	4x2,5	14,5	0,330	15	4,950	19	6,270	24	7,920
	4x4	16,5	0,435	12	5,220	18	7,830	19	8,265
	4x6	17,5	0,545	10	5,450	15	8,175	15	8,175
	4x10	19,5	0,745	9	6,705	9	6,705	14	10,430
	4x16	21,5	1,030	7	7,210	8	8,240	11	11,330
	4x25	27,5	1,610	3	4,830	5	8,050	6	9,660
	4x35	30,0	2,080	3	6,240	3	6,240	5	10,400
4x50	33,0	2,690	2	5,380	3	8,070	3	8,070	
150	4x1,5	13,0	0,250	32	8,000	42	10,500	48	12,000
	4x2,5	14,5	0,330	23	7,590	31	10,230	39	12,870
	4x4	16,5	0,435	16	6,960	24	10,440	27	11,745
	4x6	17,5	0,545	15	8,175	22	11,990	24	13,080
	4x10	19,5	0,745	14	10,430	15	11,175	21	15,645
	4x16	21,5	1,030	10	10,300	12	12,360	17	17,510
	4x25	27,5	1,610	5	8,050	5	8,050	9	14,490
	4x35	30,0	2,080	4	10,400	6	12,480	8	16,640
4x50	33,0	2,690	4	10,760	4	10,760	6	16,140	
200	4x1,5	13,0	0,250	44	11,000	58	14,500	65	16,250
	4x2,5	14,5	0,330	25	8,250	38	12,540	50	16,500
	4x4	16,5	0,435	23	10,005	33	14,355	33	14,355
	4x6	17,5	0,545	21	11,445	27	14,715	32	17,440
	4x10	19,5	0,745	19	14,155	22	16,390	29	21,605
	4x16	21,5	1,030	13	13,390	17	17,510	22	22,660
	4x25	27,5	1,610	7	11,270	10	16,100	13	20,930
	4x35	30,0	2,080	6	12,480	8	16,640	11	22,880
4x50	33,0	2,690	5	13,450	6	16,140	9	24,210	
250	4x1,5	13,0	0,250	53	13,250	74	18,500	83	20,750
	4x2,5	14,5	0,330	40	13,200	51	16,830	68	22,440
	4x4	16,5	0,435	29	12,615	44	19,140	47	20,445
	4x6	17,5	0,545	27	14,715	41	22,345	41	22,345
	4x10	19,5	0,745	23	17,135	27	20,115	35	26,075
	4x16	21,5	1,030	16	16,480	20	20,600	27	27,810
	4x25	27,5	1,610	9	14,490	13	20,930	17	27,370
	4x35	30,0	2,080	8	16,640	10	20,800	15	31,200
4x50	33,0	2,690	7	18,830	7	18,830	11	29,590	

►► Cable Layout Table (Support distance 1,5 m)

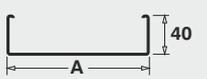
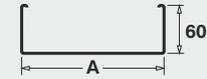
A	Values								
	Nominal Cross-section mm ²	Cable Outer Diameter mm	Net Weight (kg/m)	Quantity	Total Weight (kg/m)	Quantity	Total Weight (kg/m)	Quantity	Total Weight (kg/m)
300	4x1,5	13,0	0,250	65	16,250	86	21,500	97	24,250
	4x2,5	14,5	0,330	48	15,840	59	19,470	78	25,740
	4x4	16,5	0,435	36	15,660	53	23,055	58	25,230
	4x6	17,5	0,545	32	17,440	47	25,615	47	25,615
	4x10	19,5	0,745	29	21,605	32	23,840	44	32,780
	4x16	21,5	1,030	20	20,600	26	26,780	38	39,140
	4x25	27,5	1,610	10	16,100	14	22,540	20	32,200
	4x35	30,0	2,080	9	18,720	12	24,960	18	37,440
	4x50	33,0	2,690	8	21,520	8	21,520	13	34,970
400	4x1,5	13,0	0,250	89	22,250	118	29,500	130	32,500
	4x2,5	14,5	0,330	68	22,440	80	26,400	107	35,310
	4x4	16,5	0,435	47	20,445	71	30,885	71	30,885
	4x6	17,5	0,545	41	22,345	65	35,425	65	35,425
	4x10	19,5	0,745	40	29,800	46	34,270	59	43,955
	4x16	21,5	1,030	26	26,780	35	36,050	44	45,320
	4x25	27,5	1,610	14	22,540	19	30,590	28	45,080
	4x35	30,0	2,080	13	27,040	17	35,360	26	54,080
	4x50	33,0	2,690	11	29,590	11	29,590	18	48,420
500	4x1,5	13,0	0,250	113	28,250	113	28,250	163	40,750
	4x2,5	14,5	0,330	80	26,400	99	32,670	115	37,950
	4x4	16,5	0,435	57	24,795	87	37,845	93	40,455
	4x6	17,5	0,545	55	29,975	55	29,975	74	40,330
	4x10	19,5	0,745	49	36,505	49	36,505	44	32,780
	4x16	21,5	1,030	35	36,050	44	45,320	54	55,620
	4x25	27,5	1,610	18	28,980	26	41,860	32	51,520
	4x35	30,0	2,080	16	33,280	20	41,600	14	29,120
	4x50	33,0	2,690	14	37,660	14	37,660	22	59,180
600	4x1,5	13,0	0,250	134	33,500	178	44,500	196	49,000
	4x2,5	14,5	0,330	98	32,340	116	38,280	155	51,150
	4x4	16,5	0,435	72	31,320	105	45,675	108	46,980
	4x6	17,5	0,545	65	35,425	65	35,425	98	53,410
	4x10	19,5	0,745	58	43,210	58	43,210	88	65,560
	4x16	21,5	1,030	41	42,230	53	54,590	65	66,950
	4x25	27,5	1,610	21	33,810	31	49,910	42	67,620
	4x35	30,0	2,080	19	39,520	25	52,000	37	76,960
	4x50	33,0	2,690	17	45,730	17	45,730	27	72,630

►► Cable Layout Table (Support distance 1,5 m)

A	Values						
	Nominal Cross-section mm ²	Cable Outer Diameter mm	Net Weight (kg/m)	Quantity	Total Weight (kg/m)	Quantity	Total Weight (kg/m)
100	4x1,5	13,0	0,250	42	10,500	-	-
	4x2,5	14,5	0,330	30	9,900	-	-
	4x4	16,5	0,435	25	10,875	-	-
	4x6	17,5	0,545	20	10,900	-	-
	4x10	19,5	0,745	18	13,410	-	-
	4x16	21,5	1,030	12	12,360	-	-
	4x25	27,5	1,610	6	9,660	-	-
	4x35	30,0	2,080	6	12,480	-	-
	4x50	33,0	2,690	5	13,450	-	-
150	4x1,5	13,0	0,250	63	15,750	84	21,000
	4x2,5	14,5	0,330	48	15,840	67	22,110
	4x4	16,5	0,435	40	17,400	48	20,880
	4x6	17,5	0,545	32	17,440	48	26,160
	4x10	19,5	0,745	28	20,860	36	26,820
	4x16	21,5	1,030	19	19,570	30	30,900
	4x25	27,5	1,610	9	14,490	18	28,980
	4x35	30,0	2,080	8	16,640	14	29,120
	4x50	33,0	2,690	8	21,520	11	29,590
200	4x1,5	13,0	0,250	87	21,750	116	29,000
	4x2,5	14,5	0,330	65	21,450	91	30,030
	4x4	16,5	0,435	55	23,925	66	28,710
	4x6	17,5	0,545	42	22,890	63	34,335
	4x10	19,5	0,745	40	29,800	60	44,700
	4x16	21,5	1,030	26	26,780	43	44,290
	4x25	27,5	1,610	13	20,930	26	41,860
	4x35	30,0	2,080	12	24,960	18	37,440
	4x50	33,0	2,690	11	29,590	17	45,730
250	4x1,5	13,0	0,250	111	27,750	148	37,000
	4x2,5	14,5	0,330	83	27,390	117	38,610
	4x4	16,5	0,435	73	31,755	87	37,845
	4x6	17,5	0,545	56	30,520	81	44,145
	4x10	19,5	0,745	42	31,290	67	49,915
	4x16	21,5	1,030	33	33,990	55	56,650
	4x25	27,5	1,610	17	27,370	34	54,740
	4x35	30,0	2,080	15	31,200	23	47,840
	4x50	33,0	2,690	14	37,660	21	56,490

►► Cable Layout Table (Support distance 1,5 m)

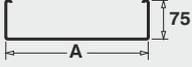
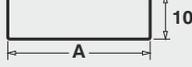
A	Values						
	Nominal Cross-section mm ²	Cable Outer Diameter mm	Net Weight (kg/m)	Quantity	Total Weight (kg/m)	Quantity	Total Weight (kg/m)
300	4x1,5	13,0	0,250	132	33,000	176	44,000
	4x2,5	14,5	0,330	100	33,000	140	46,200
	4x4	16,5	0,435	87	37,845	94	40,890
	4x6	17,5	0,545	66	35,970	99	53,955
	4x10	19,5	0,745	62	46,190	91	67,795
	4x16	21,5	1,030	39	40,170	65	66,950
	4x25	27,5	1,610	24	38,640	36	57,960
	4x35	30,0	2,080	18	37,440	29	60,320
	4x50	33,0	2,690	17	45,730	26	69,940
400	4x1,5	13,0	0,250	150	37,500	210	52,500
	4x2,5	14,5	0,330	133	43,890	186	61,380
	4x4	16,5	0,435	118	51,330	141	61,335
	4x6	17,5	0,545	88	47,960	132	71,940
	4x10	19,5	0,745	82	61,090	112	83,440
	4x16	21,5	1,030	54	55,620	90	92,700
	4x25	27,5	1,610	32	51,520	56	90,160
	4x35	30,0	2,080	25	52,000	38	79,040
	4x50	33,0	2,690	23	61,870	35	94,150
500	4x1,5	13,0	0,250	225	56,250	300	75,000
	4x2,5	14,5	0,330	168	55,440	235	77,550
	4x4	16,5	0,435	118	51,330	177	76,995
	4x6	17,5	0,545	112	61,040	168	91,560
	4x10	19,5	0,745	102	75,990	156	116,220
	4x16	21,5	1,030	68	70,040	113	116,390
	4x25	27,5	1,610	53	85,330	70	112,700
	4x35	30,0	2,080	32	66,560	48	99,840
	4x50	33,0	2,690	29	78,010	44	118,360
600	4x1,5	13,0	0,250	270	67,500	360	90,000
	4x2,5	14,5	0,330	203	66,990	284	93,720
	4x4	16,5	0,435	178	77,430	213	92,655
	4x6	17,5	0,545	134	73,030	201	109,545
	4x10	19,5	0,745	126	93,870	158	117,710
	4x16	21,5	1,030	81	83,430	135	139,050
	4x25	27,5	1,610	53	85,330	84	135,240
	4x35	30,0	2,080	38	79,040	57	118,560
	4x50	33,0	2,690	36	96,840	54	145,260

►► **Pre-galvanized**
(Material that has been through the hot dip procedure before production.)

Sheet metal manufacturers plate sheet rolls in continuous hot dip galvanizing baths. Plating thickness by this process will reach up to minimum 10-14 μm .

Material plated by the pre-galvanizing method will be protected against corrosion on cut surfaces due to the cathodic effect between the zinc and the steel elements. (It is valid and effective up to 2mm thickness).

TS EN 10143
TS EN 10346

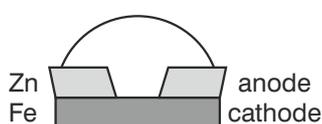
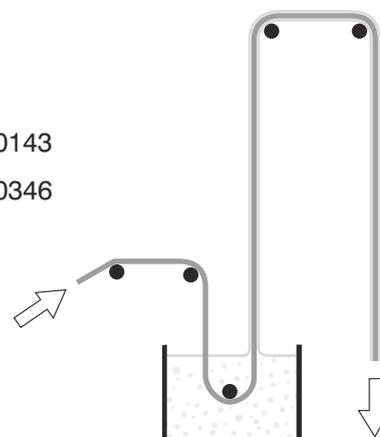

Zinc salts will prevent corrosion till no zinc will remain at all.

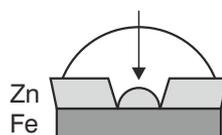

►► **Hot Dip Galvanization After Fabrication**

This method is the process of plating plain steel materials by dipping into molten zinc melt after fabrication. Plating thickness by this process will reach up to a minimum of 45 μm .

TS EN ISO 1461



Corrosion of zinc plated and unprotected steel in atmosphere.

Atmosphere Types	Erosion of zinc coating (μ/year)	Erosion of unprotected steel (μ/year)
Open field	1,0- 3,4	6 - 60
Sea side	2,4-15,0	20 -170
City	1,0- 6,0	30 - 70
Industry	3,8-19,0	30 -160
Tropical climate	1,0- 9,7	1 - 70

►► Corrosion Categories As Per DIN EN ISO 12944

Corrosion category	Typical indoor ambient	Typical outdoor ambient	Corrosion load	Average zinc layer	Suitable coating type
C 1	Buildings with fresh air and air conditioning such as Offices, Department Stores, Schools, Hotels	-	Very Low	<0,1µm/year	TS EN 10346 TS EN 10143 PREGALVANIZE
C 2	Unheated buildings where condensation may happen, for example: Warehouses, fitness centres	Environments where less pollution exists.	Low	0,1 - 0,7 µm/year	TS EN10346 TS EN 10143 PREGALVANIZE
C 3	Environments where high humidity levels and partial air pollution exist	Metropolitan and industrial environments, moderately polluted areas due to sulphur dioxide, sea-side resorts with low salt concentration.	Mild	0,7 - 2,1µm/years	TS EN ISO 1461 HOT-DIP
C 4	Chemical facilities, swimming pools, facilities over the sea.	Industrial zones and zones with low salt concentration.	Strong	2,1 - 4,2 µm/years	TS EN ISO 1461 HOT-DIP
C5	Buildings or zones where continuous condensation and strong pollution is possible.	Industrial zones where high humidity and an aggressive environment is possible.	Very Strong	4,2 - 8,4 µm/years	Duplex (Hot -Dip + Electrostatic Powder Paint Coating) or 316L-Stainless
C 6	Buildings or zones where continuous condensation occurs and strong pollution is probable.	Sea shores with a high salt concentration or open sea environments.	Extremely Strong	>4,2 - 8,4 µm/years	Duplex (Hot -Dip + Electrostatic Powder Paint Coating) or 316L-Stainless

►► Paint

Epoxy Paint;

- Resistance against chemical substances is very high.
- Resistance against corrosion is excellent
- Surface hardness is high.
- It is not suitable for exterior application since, it has no UV resistance and durability, it becomes chalky.
- Yellowing in colour may occur over time.
- Matt paints in different brightness and properties can be easily formulated.

Epoxy/ Polyester Paint;

- Resistance against exterior effects is limited.
- Yellowing in colour may occur over time.
- If there is no excessive corrosive medium or chemical effect, it is suitable to be applied inside interior locations.
- It is difficult to obtain fully matt paint.
- Mechanical properties are suitable for daily application such as impact, flexibility and scratching.

Polyester Paint;

- UV resistance is very good, it provides excellent resistance and durability under exterior conditions.
- It will not become yellowish and discolour.
- Mechanical properties are very good (such as impact, flexibility etc.)



►► Protection of Galvanized Sheet Metal during the Period of Stockpiling

By the virtue of its composition, the galvanized sheet metal is known to be particularly sensitive against the effects of materials of acidic character, polluted air, water and relative humidity present above a certain rate. The service life of galvanized sheet metal is shorter in the industrial areas where the air is densely polluted. The most important element of atmospheric air pollution is sulphur dioxide.



The sulphurous and sulphuric acid forming at various rates reacts with the zinc and causes corrosion in the layer of galvanization.

Decreasing the rate of atmospheric pollution or reducing it to zero will not be possible on an individual basis. To prevent the likely corrosion of the galvanized layer due to air pollution in stockpiling will be possible only by stockpiling the galvanized sheet metal in well protected warehouses.

The matter causing the greatest concern regarding galvanized sheet steel are the white coloured spots called white rust, which develop on the surface of sheet metal during the course of stockpiling. Its development, however, can be minimized, even completely eliminated, by taking proper measures.

The white rust is the result of a chemical reaction between zinc and the carbon dioxide, oxygen and water or moisture in the air.

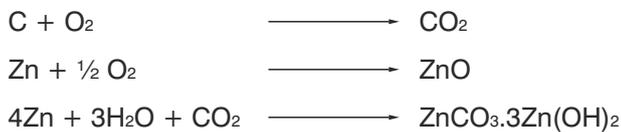

The white rust phenomenon occurs during the stockpiling of galvanized sheet metal as a result of combined action of above-stated parameters and mostly in the case of stock-piled sheet metal. As the air with a high rate of moisture will be trapped between the pieces of stocked sheet metal, any differences in temperature will cause the trapped air to reach the dew point, leading to formation of droplets of water on the surfaces of sheet metal pieces. As a result, the oxygen dissolved in water will react with Zn to produce zinc hydroxide while the carbon dioxide present in the air will react with zinc to produce zinc carbonate. The combined result of these two reactions will lead to the development of zinc carbonate zinc hydroxide, called white rust.

In order to protect the stacked sheet metal against the effects of white rust for a certain period of time, although not for long, the pieces of sheet metal are subjected to a process named passivation. During this process, a protective film is produced on the surface of galvanized sheet metal through a chemical reaction. That protective film will protect the galvanized sheet metal against the formation of white rust for a certain period of time. In order to ensure said protection, however, the following conditions must be strictly observed.

- Stacked sheet metal must never be allowed to come in contact with water.
- There must be sufficient space provided for continuous circulation of air in the place where they are stacked.
- There must be sufficient space provided for proper circulation of air between the stacks of sheet metal (min 300mm between the two stacks).
- The temperature differences in the places of stockpiling must be small (between 5-10°C).
- The relative humidity in the places of stockpiling must not exceed 70%.
- The sheet metal must not be stockpiled in places where there is air pollution.
- Where the stacked sheet metal is to be stockpiled for long periods of time, each piece of sheet metal must be examined periodically, and any droplets of water likely to be formed on the surfaces of sheet metal must be wiped off and the surfaces must be dried.
- The stacks must be placed, without fail, on wooden palettes or props as to prevent the sheet metal to come in contact with the floor.

When the above conditions are fulfilled, it will be possible to ensure proper circulation of air in the place of stockpiling, thereby ensuring the formation of white rust at a reduced level.

►► Zinga Paint

In the event that galvanized metallic products are cut and used in construction sites, the protective coating layer of the cut-off sections are damaged, and as a result, the material's strength against the corrosion is compromised. In order to avoid such a compromise and to improve the service life of the material, EAE recommends to apply ZINGA paint to cut-off sections.

ZINGA SPECIFICATIONS

- It contains 99.995% zinc as specified in ISO 3549 standard. The remaining part is composed of synthetic resin, pigments and solvents. The ZINGA layer which dries after its application to the surface contains 96% zinc in approximate.

- It protects the applied surfaces by way of two methods: Active and passive protection. The cathodic protection provided by it thanks to its high zinc content is called active protection. Zinc salts and zinc carbonates that are formed as a barrier following the application are called as passive protection.

- Its mechanical strength is high.
- It may be easily applied to locally corroded areas.
- It may be applied at such humidity values up to 95%.
- It may be easily applied by means of a brush or a roller.
- Dry ZINGA layer is not toxic.

Constituents	Zinc powder (produced by means of atomization process) Aromatic hydrocarbons binder and others
Density	2,67 kg/dm ³ (+-0,06 kg/dm ³)
Quantity of solids	80 %by weight - 58% by volume
Thinner type	Zingasolv



APPLICATION DIRECTIONS

- Surface cracks that occur after the application of cut-off process will be ground.
- Ground surfaces are wiped off by means of a piece of cloth to ensure that there remains no dust and dirt.
- In order to ensure a homogenous distribution of the mixture in Zinga, the mixer apparatus will be dipped into the box by means of a drill, and the mixture operation continues until no solid particle remains at the bottom of the box.

- After Zinga reaches desired homogeneity, it will be applied to the cut-off surface with the help of a brush that is immune to the solvent and whose bristles are not nylon.

- A double-layer Zinga will be applied to reach nearly 80-100 micron coating thickness. The first layer must be strictly applied with the brush and nearly two hours should pass after the application. Then the second layer should be applied. During the application of the second layer, a roller should be used instead of the brush to obtain a smoother surface.

►► NYY Cable Diameter and Weight Values

Nominal Cross-Section mm ²	Cable Outer Diameter mm	Net Weight kg / m
1x4	9,0	0,125
1x6	9,5	0,150
1x10	10,5	0,200
1x16	11,5	0,265
1x25	13,5	0,385
1x35	14,5	0,490
1x50	15,0	0,610
1x70	16,7	0,820
1x95	18,5	1,090
1x120	20,0	1,340
1x150	22,0	1,610
1x185	24,1	2,000
1x240	27,5	2,630
2x1,5	12,0	0,195
2x2,5	13,0	0,250
2x4	14,5	0,320
2x6	15,5	0,385
2x10	17,0	0,510
2x16	19,0	0,675
2x25	23,5	1,040
2x35	25,5	1,320
2x50	28,0	1,680
2x70	31,5	2,225
2x95	36,0	3,000
2x120	39,0	3,660
2x150	42,5	4,440
2x185	47,5	5,510
2x240	54,0	7,210
3x1,5	12,5	0,220
3x2,5	13,5	0,285
3x4	15,0	0,370
3x6	16,0	0,455
3x10	18,0	0,615
3x16	20,0	0,835
3x25	24,5	1,290
3x35	27,5	1,680
3x50	30,0	2,130
3x70	33,5	2,880
3x95	38,5	3,890
3x120	41,5	4,730
3x150	46,0	5,810

Nominal Cross-Section mm ²	Cable Outer Diameter mm	Net Weight kg / m
3x185	51,5	7,250
3x240	58,0	9,430
3x16/10	21,0	0,955
3x25/16	26,0	1,460
3x35/16	28,5	1,830
3x50/25	31,5	2,410
3x70/35	35,5	3,270
3x95/50	40,5	4,380
3x120/70	44,5	5,490
3x150/70	48,0	6,470
3x185/95	54,0	8,190
3x240/120	61,5	10,680
4x1,5	13,0	0,250
4x2,5	14,5	0,330
4x4	16,5	0,435
4x6	17,5	0,545
4x10	19,5	0,745
4x16	21,5	1,030
4x25	27,5	1,610
4x35	30,0	2,080
4x50	33,0	2,690
5x1,5	14,0	0,290
7x1,5	15,0	0,345
10x1,5	18,0	0,465
12x1,5	18,5	0,515
14x1,5	19,0	0,570
19x1,5	21,0	0,705
21x1,5	22,0	0,770
24x1,5	24,0	0,870
30x1,5	25,5	1,040
40x1,5	28,0	1,300
5x2,5	15,5	0,385
7x2,5	16,5	0,460
10x2,5	20,0	0,635
12x2,5	21,0	0,710
14x2,5	21,5	0,805
19x2,5	24,0	0,990
21x2,5	25,5	1,110
24x2,5	28,0	1,260
30x2,5	29,5	1,490
40x2,5	33,0	1,910

►► Directive

CE DECLARATION OF CONFORMITY

Product Group Cable Trays, Cable Ladders and Accessories

Manufacturer EAE Elektrik Asansor End. Insaat San. ve Tic. A.S.
Akcaburgaz Mahallesi, 3114. Sokak,
No:10 34522 Esenyurt-Istanbul

This is to attest, under our sole responsibility, that the aforementioned products conforms with the following regulations and standards.

Standard :

TS EN 61537

"Cable Tray Systems and Cable Ladder Systems"

CE - Directive

2014/35/EU "Electrical equipment designed for use within certain voltage limits"

Technical Document Preparation Official:

EAE Elektrik Asansor End. Insaat San. ve Tic. A.S.
Akcaburgaz Mahallesi, 3114. Sokak, No:10 34522 Esenyurt-Istanbul

Emre GÜRLEYEN

Date:

20.04.2016

Document Signing Authority

Elif Gamze KAYA OK
Assistant General Manager



▶▶ SYSTEM FUNCTIONALITY IN CASE OF A FIRE Universal Ladder Tray Systems & Universal Suspension Systems

32% of all fires in the world every year are still attributable to electric contacts. Moreover this ratio continues to rise instead of an anticipated decline in parallel with the technological progress. It is obvious that it is not possible to fully avoid fires; but it is possible by taking certain safety measures to gain some vitally important time to ensure the safe evacuation of people!

E30-E90 Fire Resistance Standard is the international criteria that allows the operation of functions which is required to gain this time. Its basic purpose is to ensure that certain systems that are vitally important for people during a fire, including emergency lighting, elevator or public address systems will remain operational and functional. Considering the fact that cabling for the said systems is over the cable conveyor systems, it will be more clearly understood how important these conveyor systems are in order to ensure the continuity of this functionality.

The test will take place in a special test furnace which can be heated based on the standard temperature and time curve. Cable systems are rated E30-E90 based on the level by which they maintain their functionality and they are mandatory in low voltage facilities that do not exceed standard 1 kV value.

EAE organized more than thirty product tests together with the cable manufacturers listed below. These brands include: Dätwyler, Eupen, Faber, Studer, Prysmian, Electro-Draad and (cable brands of the tests held in Russia).

While a duct or ladder is laid down, the equivalent load is determined pursuant to DIN 4102-12 / 7.3.2.4. Maximum load should be taken as 10kg/m for the ducts while it should be taken as 20kg/m for the ladders. While cables are laid down in a duct or ladder, duct bearing elements should be used at 1200mm intervals.

The test is applicable for cable and cable conveyor system combinations; it may display varieties for static structure.

►► EAE UNIVERSAL CABLE DUCTS GENERAL PRODUCT SPECIFICATIONS (UKFE) Universal Ladder Duct Systems & Universal Suspension Systems

- 1) Heavy-duty Universal Cable bearers should be used in such areas designated on the project; they should be made of perforated sheet plates to ensure the horizontal distribution of cables (edges are circularly bent inwards and nearly 10mm diameter from one edge to the other)
- 2) Universal Cable bearers with a breadth between 100 - 300 mm should be made galvanized sheet plate with a thickness of 0.7 mm; in case this breadth is between 400-600 mm, the thickness of the galvanized plate should be 0,9 mm. Right-angled edge height of cable bearer ducts should be 40mm in all ducts. However, based on the cable's cross section and density, the edge height may be 40mm in all ducts where necessary.
- 3) Sheet plate cable ducts should be manufactured in units with equal length, which should not be less than three meters.
- 4) Holes will be perforated at the edges of and into the universal cable ducts along the entire length of the duct to secure ventilation. Hole sizes should be 7 x 32 mm. Holes exactly at the mid-axis inside the interior of the duct should be a single line set of holes in parallel with the wider part of the duct. All holes should lie parallel along the duct.
These holes should be formed in minimum 3mm in order to enhance the duct strength.
- 5) In UKFE Cable bearer manufacture, galvanized sheet plate that conforms to **TS EN 10346 - TS EN 10143** standards should be used. High-quality iron-based sheet plate material should be coated with zinc by means of hot dipping method in line with **TS EN 10346 - TS EN 10143** standarts. Afterwards, universal cable ducts and accessories should be manufactured from galvanized sheet plate.
- 6) Upon demand, following this manufacture, RAL-coded epoxy polyester and electrostatic dust paint should be applied. The product should be kiln-dried at 180°C following the painting. Paint thickness should be minimum 50 µm. Painted duct and its accessories should be later packaged for protection purposes. The length of ducts with paint application over galvanize: should be L=3000 mm. (During the installation, in case of cable duct cut etc, electrostatic powder paint liquified with cellulosic thinner in a container (the consistence should be like that of oil paint) should be applied to cut-off spots by means of a brush for retouch purposes and 2 hours should pass for drying.
- 7) At places where the height of universal cable ducts changes, level change modules or level change annexations should be used.
- 8) At places where the bearer duct changes direction (based on the need): 90° horizontal turn element, horizontal (T) connection element (+) quadruplet turn elements concave rotation convex turn elements should be used. The areas where these elements are used should not be sharp angled.
- 9) In vertical ups and downs, in panel cable connections and socket group etc connections: Vertical (T) wall climbing-down element – Vertical (T) mid-climbing down/ up element should be used.
- 10) Connections between bearer ducts should be made by means of junction elements. Every size length should be 3m. 2 junction elements shall be used at every three meters. Installation of all turn elements shall be made by interlocking them to ducts (**there is no need for junction element**). Bolt holes should be in conformity with M6 additional bolt set. M6x12-dome head interlockable bolt and flanged nut sets should be used.
- 11) Due to the intense number of cables, Reduction Modules will be used for the connection of ducts with different widths.
- 12) For connection installations, **lacquer-coated** nuts or bolts etc in line with metric system (M6 Additional Bolt set) will be used.
- 13) For all connections for turn modules and reduction modules 4 M6x12 additional bolt and nut sets will be used (for H=40 mm) and 8 sets will be used (for H=60mm).
- 14) No walking on the cable duct is permitted and these should not be used as walking paths.

►► EAE UNIVERSAL CABLE TRAY SPECIFICATIONS (UKS) Universal Cable Duct Systems & Universal Hanger Systems

- 1) In the places designated in the project, the Universal Cable Trays made of perforated sheet metal steel, having side edges rounded inwards (approx. 10mm in external diameter) and designed for use in heavy duty applications should be used for horizontal distribution of cables.
- 2) The Universal Cable Trays having a width of 50-100-150mm should be made from galvanized sheet metal steel of 1 mm thickness, those having a width of 200-250mm should be made from galvanized sheet metal steel of 1.2mm thickness and those having a width of 300-400-500mm should be made from galvanized metal of 1.5mm thickness. The right-angle side height of Cable Trays should be 40mm for all Cable Trays. However, depending on the cross section and placement density of Cable Trays, the side height may be 60mm for all Cable Trays, as required.
- 3) Sheet metal steel Cable Trays should be produced as uniform units of equal length, which should not be less than 3 metres. However, on demand, they should be produced in lengths of 4, 5 and 6 metres. **Moreover, it should be possible, on demand, to produce the galvanized sheet metal steel Cable Trays without any perforations.** In non-perforated productions of imperforated type, the holes should be opened only at the joints.
- 4) On the sides and bottom of Universal Cable Trays, holes should be opened along the whole length of Cable Tray in order to ensure air circulation. The size of holes should be 7mm x 15mm, 7mm x 25mm and 7mm x 35mm. Just at the middle of Cable Tray, holes of 7mm x 25mm should be opened in a direction perpendicular to the width of Cable Tray while holes of 7x35mm should be opened in a direction parallel to the width of Cable Tray. Just at the middle of Cable Tray, holes should be opened at 170mm intervals to accommodate couplings of 20.5mm in diameter.
- 5) Galvanized sheet metal steel conforming to **TS EN 10346 - TS EN 10143** standards should be used in the production of Cable Trays. The high-quality sheet metal steel of iron base should be coated with zinc using hot-dip method conforming to **TS EN 10346 - TS EN 10143**. Following that process, the Universal Cable Trays and their accessories should be produced using the galvanized sheet metal steel so obtained.
- 6) On demand, following the above production, an electrostatic powder paint of epoxy polyester class and having RAL code should be applied. Following painting, the product should be baked at 180°C. The thickness of paint should be minimum 50µ (micron). The painted Cable Trays and their accessories should then be packed for protection. The length of painted galvanized sheet iron Cable Trays should be L = 3000mm. (During the mounting of Cable Trays if the Trays are cut or the coat of paint is damaged otherwise, the electrostatic powder paint dispersed in cellulosic thinner in a container (as to have the consistency of oil paint) should be applied using a brush as a retouch, and allowed to dry for 2 hours.
- 7) Where the Universal Cable Trays descends or ascends, the level adaptation modules and level adaptation joints should be used.
- 8) In places where the Cable Tray changes direction, the 90° horizontal elbows, "T" shaped horizontal connecting pieces plus cross shaped horizontal turning pieces. The areas of application of then pieces should not have sharp corners.
- 9) In vertical descends and ascends, in panel cable connections and in socket group connections etc., a "T" shaped vertical wall descending piece and "T" shaped vertical central descending / ascending pieces should be used.
- 10) The connection of Cable Trays to each other should be made by means of joining pieces. The length of each piece shall be 3m. Two joining pieces shall be used at every three metres. The mounting of all turning pieces to the Cable Tray shall be realized as butt joints (**no need for extra joining pieces**). The bolt holes should match the M6 joining bolt and nut set. The m6 x12 bolt and nut set comprising round headed, self-locking bolts, and flanged nuts should be used.
- 11) In the case of densely placed Cable Trays, the connection of Cable Trays of different width shall be realized using reduction modules.
- 12) In the mounting of joining pieces, the **lacquer coated** bolts and nuts (M6 Joining Bolt and Nut Set) conforming to metric system shall be used.
- 13) In the connection of all turning modules and reduction modules, four M6 x12 joining bolt and nut set for M = 40mm and eight M6x12 joining bolt and nut set for M = 60mm shall be used.
- 14) Cable trays should not be walked on or used as walkways.

►► EAE UNIVERSAL CABLE TRAY SPECIFICATIONS (UKFG) Universal Cable Tray Systems & Universal Hanger Systems

- 1) UKFG serie cable tray system is produced in 3050 mm straight length . 50 mm of the straight length overlaps on the next's 50 mm at the connection point. Special Form on the bottom holes enhance the strenght of the tray . There is no need to use Joint Connector .For grounding; M6 x 12 pan-head locking bolts and skirted flange nuts set should be used.
- 2) In the places designated in the project, the Universal Cable Trays made of perforated sheet metal steel, having side edges rounded inwards (approx. 10mm in external diameter) and designed for use in heavy duty applications should be used for horizontal distribution of cables.
- 3) The Universal Cable Trays having a width of 100-200-300mm should be made from galvanized sheet metal steel of 0.7mm thickness, those having a width of 300-400-500-600mm should be made from galvanized sheet metal steel of 0,9mm thickness The right-angle side height of Cable Trays should be 40mm for all Cable Trays. However, depending on the cross section and placement density of Cable Trays, the side height may be 50-60mm for all Cable Trays, as required.
- 4) Sheet metal steel Cable Trays should be produced as uniform units of equal length, which should not be less than 3050 mm.
- 5) On the sides and bottom of Universal Cable Trays, holes should be opened along the whole length of Cable Tray in order to ensure air circulation. The size of holes should be 7mm x 25mm, 7x28, 7x57. The holes provided at the bottom of Cable Tray just on the middle axis should be opened in a single row and in a direction parallel to the wider part of Cable Tray, while all other holes should be opened in a direction parallel to the length of Cable Tray. **In order to increase the strength of Cable Tray, the holes should be profiled.** UKFG Serie cable tray can be hanged with threaded rod from the center hole which is Ø11. Ø 25 Key Hole allows you to assembly cable gland at the center.
- 6) Galvanized sheet metal steel conforming to **TS EN 10346 - TS EN 10143** standards should be used in the production of Cable Trays.
- 7) On demand, following the above production, an electrostatic powder paint of epoxy polyester class and having RAL code should be applied. Following painting, the product should be baked at 180°C. The thickness of paint should be minimum 50µ(micron). The painted Cable Trays and their accessories should then be packed for protection. The length of painted galvanized sheet iron Cable Trays should be L = 3050mm. (During the mounting of Cable Trays if the Trays are cut or the coat of paint is damaged otherwise, the electrostatic powder paint dispersed in cellulosic thinner in a container (as to have the consistency of oil paint) should be applied using a brush as a retouch, and allowed to dry for 2 hours.
- 8) Where the Universal Cable Trays descends or ascends, the level adaptation modules and level adaptation joints should be used.
- 9) In places where the Cable Tray changes direction, the 90° horizontal elbows, "T" shaped horizontal connecting pieces plus cross shaped horizontal turning pieces. The areas of application of then pieces should not have sharp corners.
- 10) In vertical descends and ascends, in panel cable connections and in socket group connections etc., a "T" shaped vertical wall descending piece and "T" shaped vertical central descending / ascending pieces should be used.
- 11) In the case of densely placed Cable Trays, the connection of Cable Trays of different width shall be realized using reduction modules.
- 12) In the mounting of joining pieces, the **lacquer coated** bolts and nuts (M6 Joining Bolt and Nut Set) conforming to metric system shall be used.

►► EAE UNIVERSAL CABLE TRAYS GENERAL PRODUCT SPECIFICATIONS (UKF-C) Universal Ladder Tray Systems & Universal Suspension Systems

1) UKF-C cable trays should be manufactured in the size of 3050 mm and they should interlock into each other by 50mm during the installation. Installation by means of bolts is possible. A strength-enhancing form should be applied to base holes on UKF-C cable tray. There is no need for the use of junction parts. But they should be optionally suitable for use of other junction parts. For earthing purposes, M6 x 12 dome head interlockable bolt and flanged nut sets should be used.

Heavy-duty Universal Cable bearers should be used in such areas designated on the project; they should be made of perforated sheet plates to ensure the horizontal distribution of cables (edges are circularly bent inwards and nearly 10mm diameter from one edge to the other)

3) Universal Cable bearers with a breadth between 100-200-300 mm should be made galvanized sheet plate with a thickness of 0.7 mm; in case this breadth is between 300-400-500-600 mm, the thickness of the galvanized plate should be 0,9 mm. Right-angled edge height of cable bearer ducts should be 40mm in all ducts. However, based on the cable's cross section and density, the edge height may be 50-60mm in all ducts where necessary.

4) Sheet plate cable ducts should be manufactured in units with equal length, which should not be less than 3050mm.

5) Holes will be perforated at the edges of and into the universal cable ducts along the entire length of the duct to secure ventilation. Hole sizes should be 7 x 25, 7 x 28, 7 x 57 mm. Holes exactly at the mid-axis inside the interior of the duct should be a single line set of holes in parallel with the wider part of the duct. All holes should lie parallel along the duct. **These holes should be formed in minimum 3mm. in order to enhance the duct strength.** There should be Ø 25 bush and Ø 11 rod noles at 87.5mm intervals exactly at the mid of the duct.

6) In **UKF-C** Cable bearer manufacture, galvanized sheet plate that conforms to **TS EN 10346 - TS EN 10143** standards should be used

7) Upon demand, following this manufacture, RAL-coded epoxy polyester and electrostatic dust paint should be applied. The product should be kiln-dried at 180°C following the painting. Paint thickness should be minimum 50 µm. Painted duct and its accessories should be later packaged for protection purposes. The length of ducts with paint application over galvanize: Paint thickness should be minimum 50 µm. (During the installation, in case of cable duct cut etc, electrostatic powder paint liquified with cellulosic thinner in a container (the consistence should be like that of oil paint) should be applied to cut-off spots by means of a brush for retouch purposes and 2 hours should pass for drying.

8) At places where the height of universal cable ducts changes, level change modules or level change annexations should be used.

9) At places where the bearer duct changes direction (based on the need): 90° horizontal turn element, horizontal (T) connection element (+) quadruplet turn elements concave rotation convex turn elements should be used. The areas where these elements are used should not be sharp angled.

10) In vertical ups and downs, in panel cable connections and socket group etc connections Vertical (T) wall climbing-down element – Vertical (T) mid-climbing down/ up element should be used.

11) Due to the intense number of cables, Reduction Modules will be used for the connection of ducts with different widths.

12) For connection installations, **lacquer-coated** nuts or bolts etc in line with metric system (M6 Additional Bolt set) will be used.

►► EAE UNIVERSAL CABLE LADDER SPECIFICATIONS (UMK) Universal Cable Duct Systems & Universal Hanger Systems

- 1) Universal Cable Ladders shall be used in the places designated in the project for horizontal and vertical distribution of low current and telephone cables and for vertical as well as horizontal (when required) support of power and supply cables. The Universal Cable Ladders shall have sides with edges rounded inwards (approx. 10mm in external diameter), designed for use in heavy duty applications.
- 2) The Universal Cable Ladders having a width of 100mm shall be made from galvanized steel metal of 0.8mm thickness, those having a width of 200mm shall be made from galvanized sheet steel metal of 1mm thickness and those having a width up to 300, 400mm shall be made from galvanized sheet steel metal of 1.2mm thickness.
- 3) Galvanized Sheet Steel Metal Cable Ladders shall be produced as uniform units of equal length of 3 metres.
- 4) The sides of Cable Ladders shall be provided with holes opened along the whole length of Cable Ladder in order to ensure air circulation. The holes shall be 7mm x 32mm in size. The Cable Ladders shall be produced as one integral piece, the rungs being connected to the body of Cable Ladder without welding. The distance between the rungs shall be 125mm from axis to axis. The surface of rungs shall be provided with holes of 12mm diameter, spaced in intervals of 25mm. The Universal Cable Ladders shall be compatible with all of the turning modules of heavy duty type Cable Ladders having sides with a height of 60mm.
- 5) Cable Ladders should be produced using sheet steel metal conforming to **TS EN 10346 - TS EN 10143** standards. The high-quality sheet steel metal of iron base should be coated with zinc using hot-dip method conforming to **TS EN 10346 - TS EN 10143** standards. Following that process, the Universal Cable Ladders and their accessories should be produced using the galvanized sheet steel metal so obtained on demand, the Cable Ladders shall be painted with an electrostatic powder paint of epoxy polyester class conforming to RAL specifications. The thickness of paint should be minimum 50 microns.
- 6) In places where the Cable Ladder descends or ascends, the level adaptation modules or level adaptation joints shall be used.
- 7) In places where the Cable Ladder changes direction, the 90° horizontal elbows, "T" shaped horizontal connecting pieces and cross shaped horizontal turning pieces shall be used.
- 8) In vertical descends and ascends, in panel cable connections and in socket group connections etc. "T" shaped vertical wall descending piece "T" shaped vertical central descending / ascending pieces shall be used.
- 9) The connection of Cable Ladders to each other shall be made by means of joining pieces. The mounting of all turning pieces to the Ladder shall be realized as butt joints (**no need for extra joining pieces**). The length of each piece shall be 3m. Two joining pieces shall be used at every three metres. The bolt holes of joining pieces should match the M6 joining bolt and nut set.
- 10) In the case of densely placed Cable Ladders, the connections of Cable Ladders of different width shall be realized using reduction modules.
- 11) In the mounting of joining pieces, the **lacquer coated** M6 x 12 bolt and nut set conforming to metric system should be used. The bolts should be round headed, flanged and self-locking into their holes. The M6 nuts should be flanged and snug headed.
- 12) In the connection of all turning modules and reduction modules, eight M6 x 12 joining nut and bolt set should be used.
- 13) Cable ladders should not be walked on or used as walkways.

►► **EAE Sheet Metal Cable Ladder General Product Specifications (KM)**
E-Line Cable Ladder Systems and Hanger Systems

1. Used for supporting of cables in project specified floor, horizontal and vertical distribution.
2. The stiffening bends of the side walls of the cable ladder should be 10 mm on top and 26 mm on bottom.
3. The slots for joint connection on the edges of the ladder should be 7x20 in size.
4. Cable ladder rungs should be riveted to sides of the ladder in 300 mm spacing.
5. In order to strengthen the cable ladder side walls, side walls should be formed along the side wall length.
6. Form count of the cable ladders should be one for 40-50-60 mm side wall heights, two for 75-100 mm side wall heights and three for 125-150 mm side wall heights.
7. Cable ladders should be produced in 3 m equal lengths. Upon request, should be able to be produced in 6 m lengths.
8. Cable ladders should be able to be folded only in one way.
9. Rungs of the cable ladders should be produced in C shape. C-shape rung should be 10 mm in height, 27 mm in width and the slots of the rung should be 7x15 mm in 25 mm axis spacing.
10. Production of cable ladders should follow **TS EN 61537**, **TS EN ISO 1461** standards. After puncture and bending, high quality iron based sheet material should be hot-dip galvanized following **TS EN ISO 1461** standard and coated with zinc. Before galvanization, required cleaning and oil removing processes should be done. After this process, washing and drying should be done and then flux bath process should be followed. Galvanize thickness should be min 14µm.
11. Sheet metal used in production of cable ladders should be according to **TS EN 10346 - TS EN 10143** standard. High quality iron based sheet material should be hot-dip galvanized according to **TS EN 10346 - TS EN 10143** standard. afterwards, production of cable ladder and accessories should be done with galvanized sheets.
12. In places where the Cable Ladder descends or ascends, the level adaptation modules or level adaptation joining pieces should be used.
13. The connection of Cable Ladders to each other should be made by means of two joining pieces for each Ladder. The mounting of all turning pieces to the Cable Ladder should be made using joining pieces.
14. In places where the Cable Ladder changes direction, the 90° horizontal elbows, "T" shaped horizontal connecting pieces and across shaped horizontal turning pieces should be used.
15. In the case of densely placed Cable Ladders, the connections of Cable Ladders of different width should be realized using the reduction modules. The central reduction module should comprise two symmetrical pieces. The left and right reduction modules should comprise a combination of one normal reduction piece and one joining piece.
16. In the mounting of joints, the lacquer coated M6 bolts and nut set should be used. The size of bolts should conform to M6 x12. The bolts should be round headed, flanged and capable of self locking into their holes. The M6 nuts should be flanged and snug headed.
17. For the mounting of both joining modules and reduction modules, 4 joining bolt and nut sets should be used for Cable Ladders having a side height of 40-50-60mm while 8 sets should be used for a side height of 75-100-125 mm and 12 sets for a side height of 150mm.
18. Cable trays should not be walked on or used as walkways.

►► EAE TKS TRUNKING CABLE TRAYS GENERAL PRODUCT SPECIFICATION (TKS)

EAE TRUNKING SYSTEM	The EAE trunking system is simple to use it is easily transported, and quick to install. The system also includes lightning and mechanical protection, for both the low current and high current installations.
	To increase strength, the tray edges have been produced using non-perforated and inwardly bent metal.
	The standard straight lengths are produced as 3m lengths.

EAE Trunking Tray System Table product scale shows a variety of products according to their outer sizes. Height and width values are stated below.

50 x 50	75 x 75	100 x 100	150 x 150
50 x 75	75 x 100	100 x 150	100 x 200

For the production of 100x200 and 150x150 trays 1.5mm pre galvanized sheet steel is used, for other tray sizes 1,2 mm thickness is used.

Straight trays and riser modules are supplied with covers.

For straight trays, 3 fixing points are provided to lock the covers into place. Each lock point needs 2 units for the 100, 150 and 200 mm widths and 1 unit for the covers which have a width of 50 and 75 mm.

TKS Series Trunking Tray Covers have a specific locking system. It can be simply locked by turning the lock a quarter turn of the way round. A tongue placed underneath the cover is used to fix the cover by simply turning it a quarter turn.

The tray being earthed is vital for the telephone and data cables. EAE Trunking Ladder In this system every straight piece and elbow at all joints have positions for lowering the resistance of the earth continuity and transition link. The links for these are provided in the product range.

Straight module Channels and TKS Modules are able to be fixed together.

Two connecting components must be used at each connector point.

Depending on the height of the cable Tray system at joints the use of M6x12 pan-head screws and M6 square nut with serrated edges can be changed with Additional screw modules.

For 50 and 75 mm height there are two sets of each connector component.

For 100 mm height there are four sets of each connector component.

For 150 mm height there are six bolt sets for each connector component.

Connector components are used during the assembly of the riser module.

Connectors are attached with the help of the pieces already found on the modules.

Riser modules are produced with circular pieces making it easy to use especially with soft canals, as it doesn't have a negative effect on the cables used.

Pregalvanized Trunking Duct System:

Raw materials in line with TS EN 10346 - TS EN 10143 standards should be used. Total galvanized dipping thickness should be 14 μm .

Hot Dipping Trunking Duct System:

Hot dipping should be applied according to TS EN 1461 standards. Total galvanized dipping thickness should be 45 - 55 μm .

►► **EAE UNIVERSAL sheet steel CABLE TRAYS PRODUCT SPECIFICATIONS (CTHF-E)**
Universal Cable Tray Systems & Universal Hanger Systems

- 1) In places where indicated on the project, Universal Cable Carriers made of perforated sheet steel in order to horizontal lay-out of the cables, in heavy duty characteristics (the laterals are bended inwards in round shape, having a diameter of 10 mm approximately outer-to-outer dia).
- 2) Universal Cable Carriers with a width in a range of 100 - 200 mm should be made of galvanized metal sheet plates of 0,8 mm in thickness; the ones with a width in a range of 300-400 mm should be made from 1,0mm in thickness; and the ones with a width up to 500-600 mm should be made of galvanized sheet steel with 1,2 mm in thickness. The height of the lateral side with right angle at the cable carriers should be 40 mm for all ducts. However according to the cable cross-sectional area and density, in case it is required, the height of the lateral side should be up to 40-50-60mm.
- 3) Sheet steel Cable Ducts should be manufactured in units with equal-length and their lengths should not be less than 3 m.
- 4) At the laterals and inside the Universal cable ducts in order to provide the ventilation there should be holes perforated along with the entire duct. Dimensions of the holes should be 7 x 32 mm. The holes that are just at the mid-centre of the inner side of the duct should be in a single line of holes as parallel to the wider side of the duct and; the other holes should be in parallel to the elongation of the duct. **In order to enhance the strength of the duct, these holes should be formed.**
- 5) At the **CTHF-E** Cable duct production it should be complied with **TS EN ISO 1461** standards. The iron based sheet steel material in high quality after the perforation and bending process should be zinc-coated through hot-dip method as per **TS EN ISO 1461** standards. Prior to zinc-coating the required cleaning and degreasing procedures should be carried out. For the finishing process the cleaning, rinsing should be done and than, a flux bath should be applied. The thickness of galvanize should be minimum 45 μm . After the galvanizing procedure the final check and cleaning of the material should be done.
- 6) In case it is requested, after this manufacturing, electrostatic powder paint with a RAL code and made of epoxy polyester material should be applied. After the painting procedure, it should be baked at 180° C in an oven. The thickness of the paint should be minimum 50 μm . Later, the painted ducts and its accessories should be packaged for the protection purposes. The length of the painted ducts made of galvanize should be L=3000 mm. (In case cable duct cuts, etc. happens during the installation, the electrostatic paint which is diluted in cellulose thinner in a cup – it must be in viscosity of oil paint- should be touched up with a brush where the cut places and be waited for 2 hour to dry up.
- 7) In places where the heights of the Universal Cable Ducts happen to vary, a level modifying module or level modifying appendixes should be used.
- 8) In places where the Carrying Duct changes direction (as per the requirement): A 90° horizontal turning element, an horizontal (T) Connection element, a quadruple (+) turning element, a Concave turning elements and a convex turning elements should be used. The usage sectors of these elements should not be sharp-edged.
- 9) At the vertical rising and declining, panel cable connections, socket group, etc. connections: Vertical (T) declining element from the wall – Vertical (T) Declining/Rising from the center element should be used.
- 10) The inter-connections of the carrying Ducts should be made by Attachment Elements. The length of each size is 3 m. 2 pieces of joint element per each three metres shall be used. The installation of the all returning elements shall be made by intertwining to each other (**there is no need to joint element**). The holes for the bolts should be compatible with the M6 joint bolts set. M6x12- round head lockable bolt and skirted-flanged nuts set should be used.
- 11) Due to cable intensity, the connection of ducts used at different width values shall be made by means of Reduction Modules.
- 12) For the installation of the connections, **Laquer coated**, bolts and nuts etc. (M6 Joint Bolts set) as per metric system shall be used.
- 13) For all connections of the return modules and reduction modules (for H=40-50mm), 4 each (for H=60mm) and 8 each M6x12 Joint bolts and nuts set should be used.
- 14) Cable trays should not be walked on or used as walkways.

►► EAE UNIVERSAL CABLE TRAY SPECIFICATIONS (CTH-CTA) Universal Cable Tray Systems & Universal Hanger Systems

- 1) In the places designated in the project, the Cable Trays of EAE brand made of perforated (Imperforated should read non-perforated) sheet steel, having side edges rounded inwards (approx. 10mm in external diameter) and designed for use in heavy duty applications should be used **for horizontal distribution of cables**.
- 2) Sheet steel Cable Trays should be produced as uniform units of equal length of $L = 3m$.
- 3) Long holes should be opened at the bottom and on the sides of Cable Trays in order to ensure air circulation. The holes should be in 3 different sizes in the order of 25mm x 7mm 15mm x 7mm 35mm x 7mm, successively. The holes should be free of any burrs. On demand, it should be possible to produce Cable Trays without any holes. (In the case of imperforated Cable Trays, the holes should be opened only at the joints.). **The perforation rate should be Class C conforming to TS EN 61537.**
- 4) It is essential that low current installation cables are segregated either by a metal separator, the same length and height of the cable tray, which should be fixed into the cable tray, or alternatively the low current cables should be run in a separate cable tray. The cables should be fixed to the Cable Tray by means of a plastic cable strip.
- 5) In the production of Cable Trays, the **TS 914 EN ISO 1461** standards should be complied with. Following the drilling and rolling process, the high-quality sheet steel of iron base should be coated with zinc using the hot dip method conforming to **TS 914 EN ISO 1461** standards. Prior to zinc coating process, the necessary cleaning and oil removing treatments should be made. As a final treatment, the product should be washed, rinsed and then subjected to a flux bath. The thickness of galvanizing coat should be 45 μ (micron). Following the galvanizing process, the final controls and cleaning of the product should be made.
- 6) In places where the Cable Tray descends or ascends, the level adaptation modules or level adaptation joining pieces should be used.
- 7) In places where the Cable Tray changes direction, the 90° horizontal elbows, "T" shaped horizontal connecting pieces and cross shaped horizontal turning pieces should be used.
- 8) In vertical descends and ascends, in panel cable connections and in socket group connections etc., "T" shaped wall descending piece and "T" shaped vertical central descending / ascending pieces should be used.
- 9) The connection of Cable Trays to each other should be made by means of two joining pieces for each Ladder. The mounting of all turning pieces to the Cable Tray should be made using joining pieces.
- 10) In the case of densely placed Cable Trays, the connections of Cable Trays of different width should be realized using the **"Z" type** reduction modules. The central reduction module should comprise two symmetrical pieces. The left and right reduction modules should comprise a combination of one normal reduction piece and one joining piece.
- 11) In the mounting of joints, the lacquer coated M6 bolt and nut set should be used. The size of bolts should conform to M6 x12. The bolts should be round headed, flanged and capable of self locking into their holes. The M6 nuts should be flanged and snug headed.
- 12) For the mounting of both joining modules and reduction modules, 4 joining bolt and nut set should be used for Cable Trays having a side height of 40-50-60mm while 8 sets should be used for a side height of 75mm and 12 sets for a height of 100mm.
- 13) Cable trays should not be walked on or used as walkways.

►► EAE UNIVERSAL CABLE LADDER SPECIFICATIONS (KMH-KMA) Universal Cable Ladder Systems & Universal Hanger Systems

- 1) Universal Cable Ladders shall be used in the places designated in the project for supporting power cables in their horizontal and vertical distribution.
- 2) The upper edge of sides of Cable Ladders should be provided with a bend of 16mm x 10mm in order to increase their strength, and the lower edge should be provided with a 25mm bend for welding rungs.
- 3) The holes opened on the sides of Cable Ladders for the purpose of making joints shall be 7mm x 20mm in size.
- 4) The rungs of Cable Ladders shall be welded to the sides at intervals of 300mm.
- 5) The Cable Ladders should be produced from metal sheet of 1.5mm or 2mm thickness. The sheet steel thickness of rungs should be same as the thickness of sheet steel at the sides.
- 6) The Cable Ladders should be produced in equal lengths of 3m.
- 7) The rungs of Cable Ladders should be produced in type omega or type C.
 - a) U rungs should have a height of 15mm with holes of 7.5mm x 15mm opened at intervals of 19mm from centre to centre.
 - b) C rungs should have a height of 18mm with holes of 7.5mm x 18mm opened at intervals of 19mm from centre to centre.
- 8) In the production of Cable Ladders, the **TS EN 61537 TS 914 EN ISO 1461** standards should be complied with. Following the drilling and bending process, the high quality sheet steel of iron base should be coated with zinc using the hot dip method conforming to **TS 914 EN ISO 1461** standards. Prior to zinc coating process, the necessary cleaning and oil removing treatments should be made. After said treatments, the product should be washed, rinsed and then subjected to a flux bath. The thickness of galvanizing coat should be 45m (micron).
- 9) In places where the Cable Ladder descends or ascends, the level adaptation modules or level adaptation joining pieces should be used.
- 10) The connection of Cable Ladders to each other should be made by means of two joining pieces for each Ladder. The mounting of all turning pieces to the Cable Ladder should be made using joining pieces.
- 11) In places where the Cable Ladder changes direction, the 90° horizontal elbows, "T" shaped horizontal connecting pieces and cross shaped horizontal turning pieces should be used.
- 12) In the case of densely placed Cable Ladders, the connections of Cable Ladders of different width should be realized using the **"Z" type** reduction modules. The central reduction module should comprise two symmetrical pieces. The left and right reduction modules should comprise a combination of one normal reduction piece and one joining piece.
- 13) In the mounting of joints, the lacquer coated M6 bolts and nut set should be used. The size of bolts should conform to M6 x12. The bolts should be round headed, flanged and capable of self locking into their holes. The M6 nuts should be flanged and snug headed.
- 14) For the mounting of both joining modules and reduction modules, 4 joining bolt and nut sets should be used for Cable Ladders having a side height of 40-50-60mm while 8 sets should be used for a side height of 75mm and 12 sets for a side height of 100mm.
- 15) Cable ladders should not be walked on or used as walkways.

►► EAE CABLE BASKET SYSTEMS - GENERAL PRODUCT FEATURES (TLS) E-Line Cable Baskets and Support Systems

1. In the places designated in the project, used to carry for horizontal and vertical distribution of cable.
2. Cable Baskets should be produced as uniform units of equal length of L=3m.
3. Horizontal and vertical strings of Cable Basket are produced as Ø4 and Ø5.
4. Cable Baskets are created with horizontal strings combined 100mm spacing in the vertical direction or created with vertical strings combined 50mm spacing in the horizontal direction.
5. It is essential that low current installation cables are segregated either by a metal separator, the same length and height of the cable tray, which should be fixed into the cable tray, or alternatively the low current cables should be run in a separate cable tray. The cables should be fixed to the Cable Basket by means of a plastic cable strip.
6. Following the drilling and rolling process, the high-quality wire of iron base should be coated with zinc using the hot dip method conforming to Electro Galvanized (EG) (DIN 50961, TSE 149) Standards. Electro Galvanized is a method that allows adhesion of steel by electrolysis. Revealed coating thickness in the range of 10-15 microns by electro galvanizing method. Electro-galvanized products are suitable for indoor applications and represent approximately 96 hours of endurance testing in salt. Products have clean, smooth and shiny appearance.
7. YD, T, AD turning modules process of Cable Basket are completed either as a single product or cutting-joining methods like described in catalog.
8. Cable Baskets should be done with three additional element for connection to each other. And installation of turning pieces should be done with additional elements.
9. In the mounting of joints, the lacquer coated M8 bolt and nut set should be used. The size of bolts should conform to M8x16. The bolts should be round headed, flanged and capable of self locking into their holes. The M8 nuts should be flanged and snug headed.
10. Cable trays should not be walked on or used as walkways.

►► EAE CABLE BASKET SYSTEMS - GENERAL PRODUCT FEATURES (TLS) E-Line Cable Baskets and Support Systems

1. In the places designated in the project, used to carry for horizontal and vertical distribution of cable.
2. Cable Baskets should be produced as uniform units of equal length of L=3m.
3. Horizontal and vertical strings of String Cable Trays are produced as Ø4 and Ø5.
4. Cable Baskets are created with horizontal strings combined 100mm spacing in the vertical direction or created with vertical strings combined 50mm spacing in the horizontal direction.
5. It is essential that low current installation cables are segregated either by a metal separator, the same length and height of the cable tray, which should be fixed into the cable tray, or alternatively the low current cables should be run in a separate cable tray. The cables should be fixed to the Cable Basket by means of a plastic cable strip.
6. Following the drilling and rolling process, the high-quality wire material of stainless base should be pacified by chemical processing (acid cleaning and passivation of the surface cleaning) is prevented that may occur color changes from thermal effects with the stainless steel method conforming to (SS4 & SS6) (AISI 304 / 1.4301, AISI 316 / 1.4404) Standards. Grade 316 of stainless steel is preferred especially in marine and industrial environments. Grade 316 of stainless steel is one of molybdenum-containing austenitic class stainless steel, has high anticorrosive and mechanical properties. Especially prone to forming and welding. Products are suitable for marine environment, petroleum and chemical plants. Grade AISI 304 (1.4301) of stainless steel is used in factory, fronts and similar corrosion level environments, because of high anti-corrosive properties. No need for extra coating on stainless steel surfaces. Grade AISI304 and 316 of stainless steel is ideal material for extreme corrosive environments.
7. YD, T, AD turning modules process of Cable Basket are completed either as a single product or cutting-joining methods like described in catalog.
8. Cable Baskets should be done with three additional element for connection to each other. And installation of turning pieces should be done with additional elements.
9. In the mounting of joints, the lacquer coated M8 bolt and nut set should be used. The size of bolts should conform to M8x16. The bolts should be round headed, flanged and capable of self locking into their holes. The M8 nuts should be flanged and snug headed.
10. Cable trays should not be walked on or used as walkways.

►► Packaging

1- Cable Trays&Ladders and Modules are packed using wooden pallets in order to ensure safe transportation to site. After being stacked on the wooden pallets the products are bound to the pallet using PVC strapping to prevent the goods sliding from the pallet. Wooden laths nailed on the sides and onto the palette ensure protection against forces that may possibly come from above and sides.

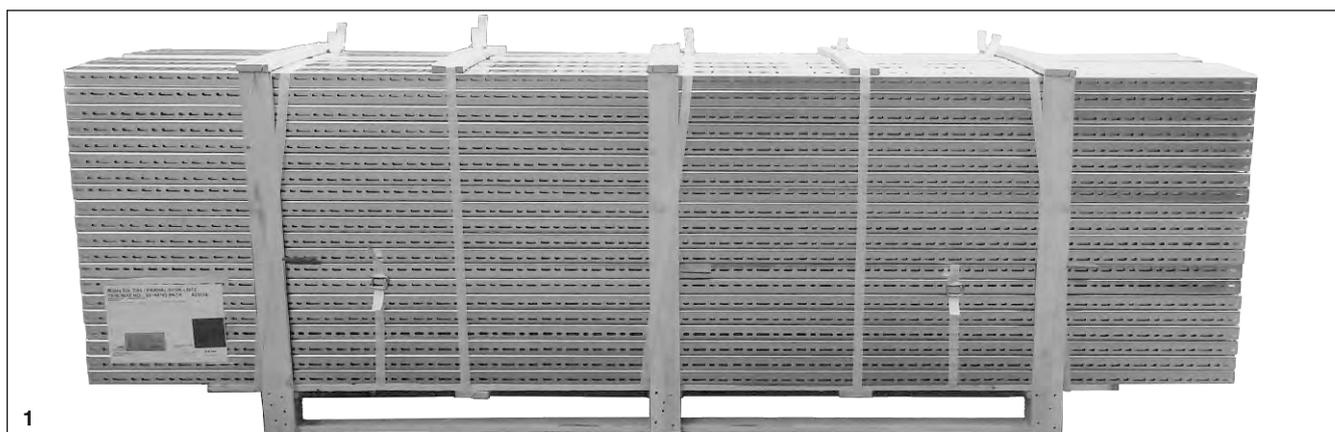

2- Support and suspension equipment used in the installation of the cable tray is covered using shrink wrap. Packages do not contain more than a total weight of 25 kg of product to facilitate the ease of transport. Product amount within the package are stuck onto the package are arranged in 10 units or tenfold unit to facilitate counting. Labels containing the code, description, small technical drawing of the product and specifying the content and amount within the package are adhered onto the packages for easy product identification. Small product packages then are stacked onto wooden palette and wrapped against scattering and supported on the sides using PVC strapping.



3 - Accessories such as joint components, screws, nuts, dowels etc, are packed within cardboard parcels. in order to prevent screws, nuts, washers and dowels from rusting., they firstly are put into nylon bags. All parcels are prepared not exceeding 25kg and are identified by labels indicating product information. Small product packages then are stacked onto wooden palette and wrapped against scattering and supported on the sides using PVC strapping.

All pallets are identified with labels indicating product information contained within. Palette labels also contain customer information and pallet total weight.

Package type above is for large scale projects. It may differ for small deliveries and warehouses.