



EV CHARGING STATIONS

Energy Distribution Solutions





EAE Group in numbers;



1973
year of foundation

Founded in 1973, EAE Elektrik A.S. being the parent company of EAE Group is a worldwide manufacturer of electrical products.

Founded : 1973
Closed Manufacturing Area : 280.000m²
Range of Products : Busbar Power Distribution Systems
 Lighting Busbar Systems
 Cable Tray Systems
 Underfloor Trunking
 Trolley Busbar Systems



280.000m²
closed manufacturing
area

Companies : EAE Elektrik
 EAE Aydınlatma
 EAE Elektroteknik
 EAE Teknoloji
 EAE Makina



5
manufacturing
plants

Number of Plants : 5

"Lean Production" and "Innovative and Customer-Driven Product Development" approaches are the key values utilized in designing and manufacturing the product families in compliance with ISO 9001, ISO 14001, OHSAS 18001, and ISO 27001.



3
R&D Centers

EAE Elektrik A.S. busbar products are certified by KEMA/DEKRA (Nederland), KEMA - KEUR, UL classified laboratories as per IEC 61439-1/6 standards.



100+
countries to export

EAE Group exports to more than 100 countries through local offices/dealers in Italy, Germany, the U.S.A., Australia, Russia, France, Spain, the UK, Portugal, the U.A.E, KSA, Vietnam, and India and provides all the necessary project design support and custom & site services.

EV CHARGING STATIONS

EAE Products

▶▶ EAE Product Types

- Busbar Power Distribution Systems
- Trolley Busbar Systems
- Fit-out Solutions
- Cable Management Systems
- Lighting Solutions
- Panel Enclosures, Distribution Boxes
- Lighting Automation

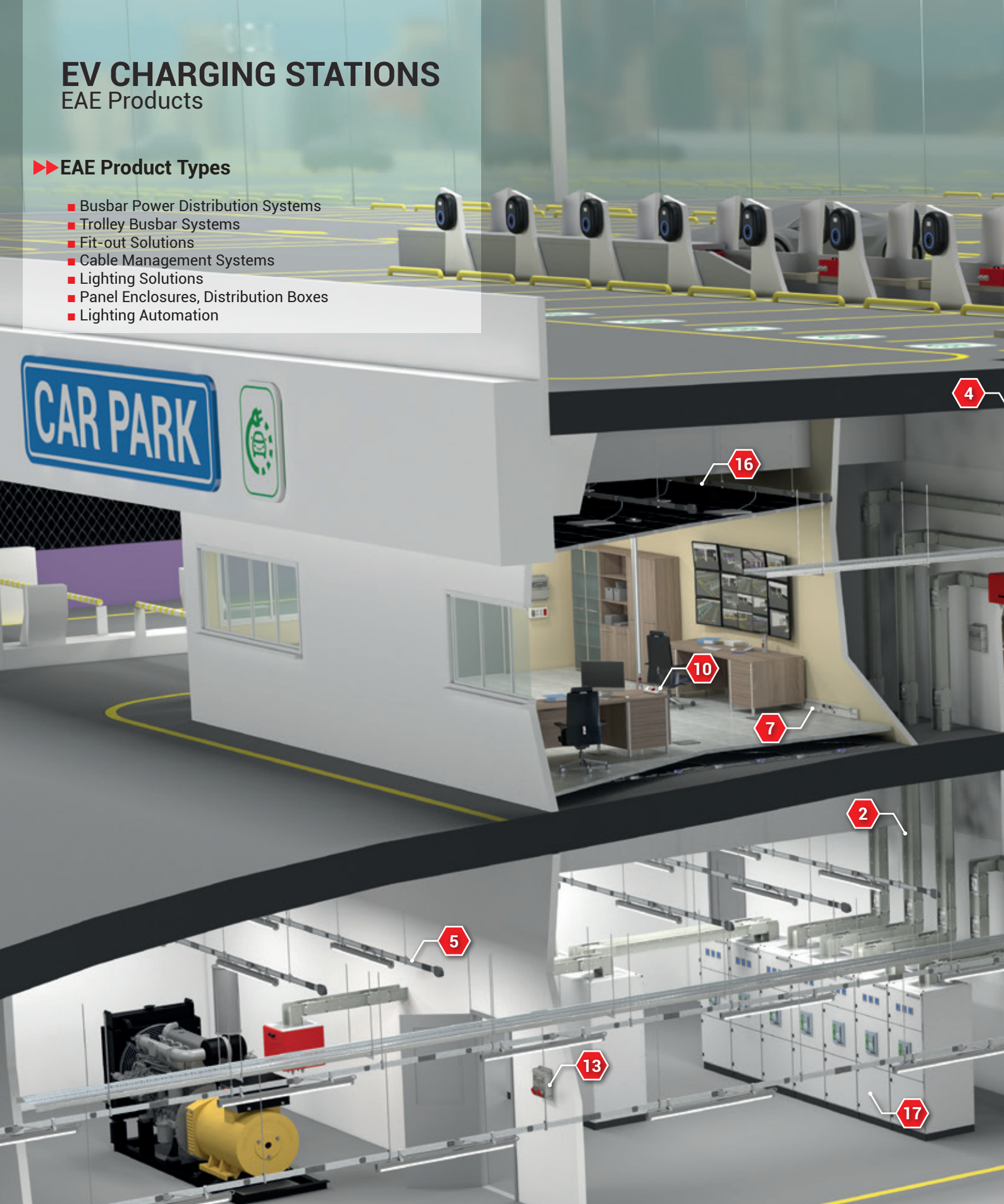

■ Busbar Power Distribution Systems

- 1- E-LINE CR - Cast Resin Busbar Systems
 - 2- E-LINE KX - Compact Busbar Systems
 - 3- E-LINE KO-II - Busbar Systems
 - 4- E-LINE CR/KX - Busbar Transition Module
 - 5- E-LINE KY-S - Multi-conductor Lighting Busbar Systems
- #### ■ Cable Management Systems
- 6- E-LINE UK - Cable Tray and Support Systems

■ Fit-out Solutions

- 7- E-LINE FL/FLD - Indoor Busbar Systems
- 8- DABLINE - Raised Floor Power Systems
- 9- E-LINE N-DK - Underfloor and Raised Floor Solutions
- 10- E-LINE SMART - Multi-outlet Extension Blocks
- 11- E-LINE MINI - Mini Series Pop-up and IP66 Outlet Boxes
- 12- E-LINE WSB - Wall Type Moduler Socket Boxes
- 13- E-LINE MULTIBOX - Socket Combination and MCB Boxes

■ Lighting Solutions

- 14- LINE ETANJ - Lighting Solutions
 - 15- PROLIT PLUS - Outdoor Lighting Systems
 - 16- BLOOM-S - Lighting Solutions
- #### ■ Panel Enclosures, Distribution Boxes
- 17- Panel Master - Cabinets

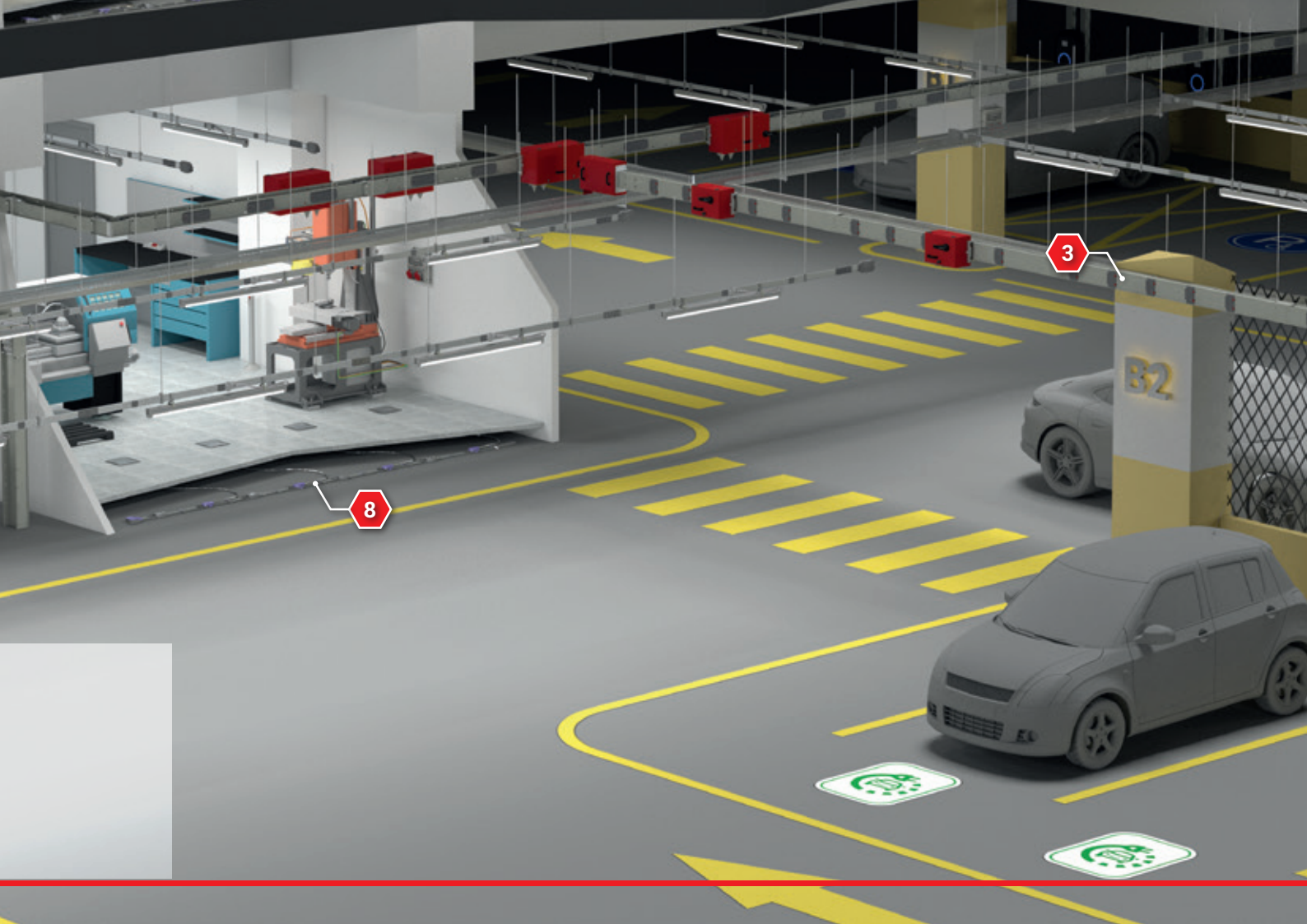
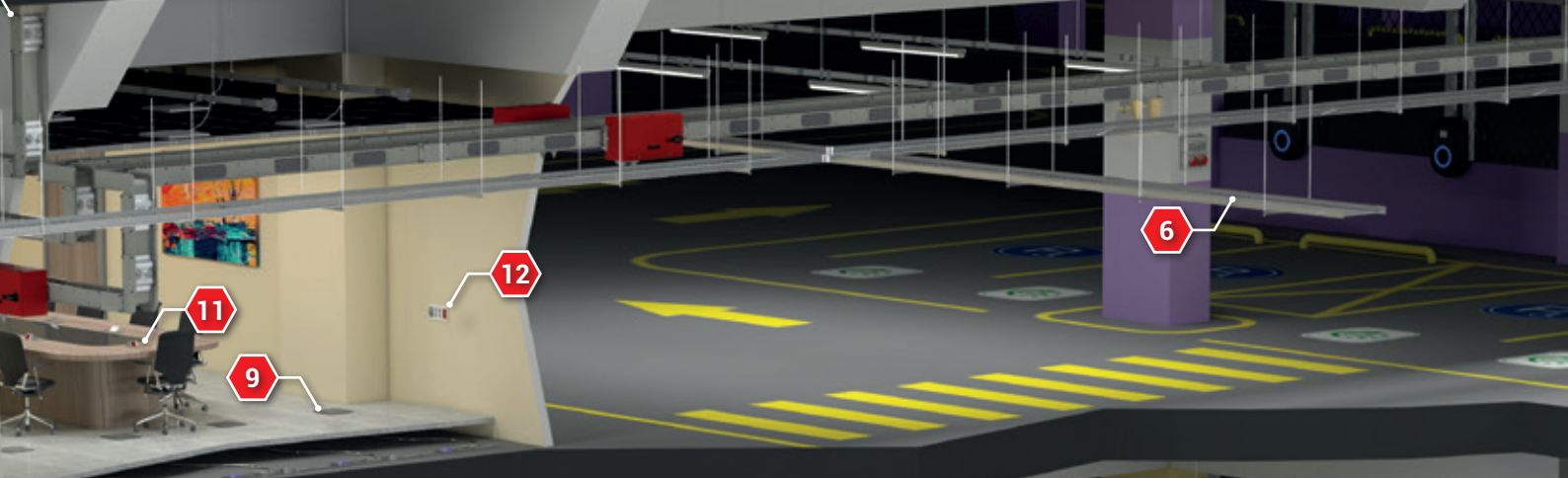

15



14

EV CHARGING STATIONS

EAE Provides...

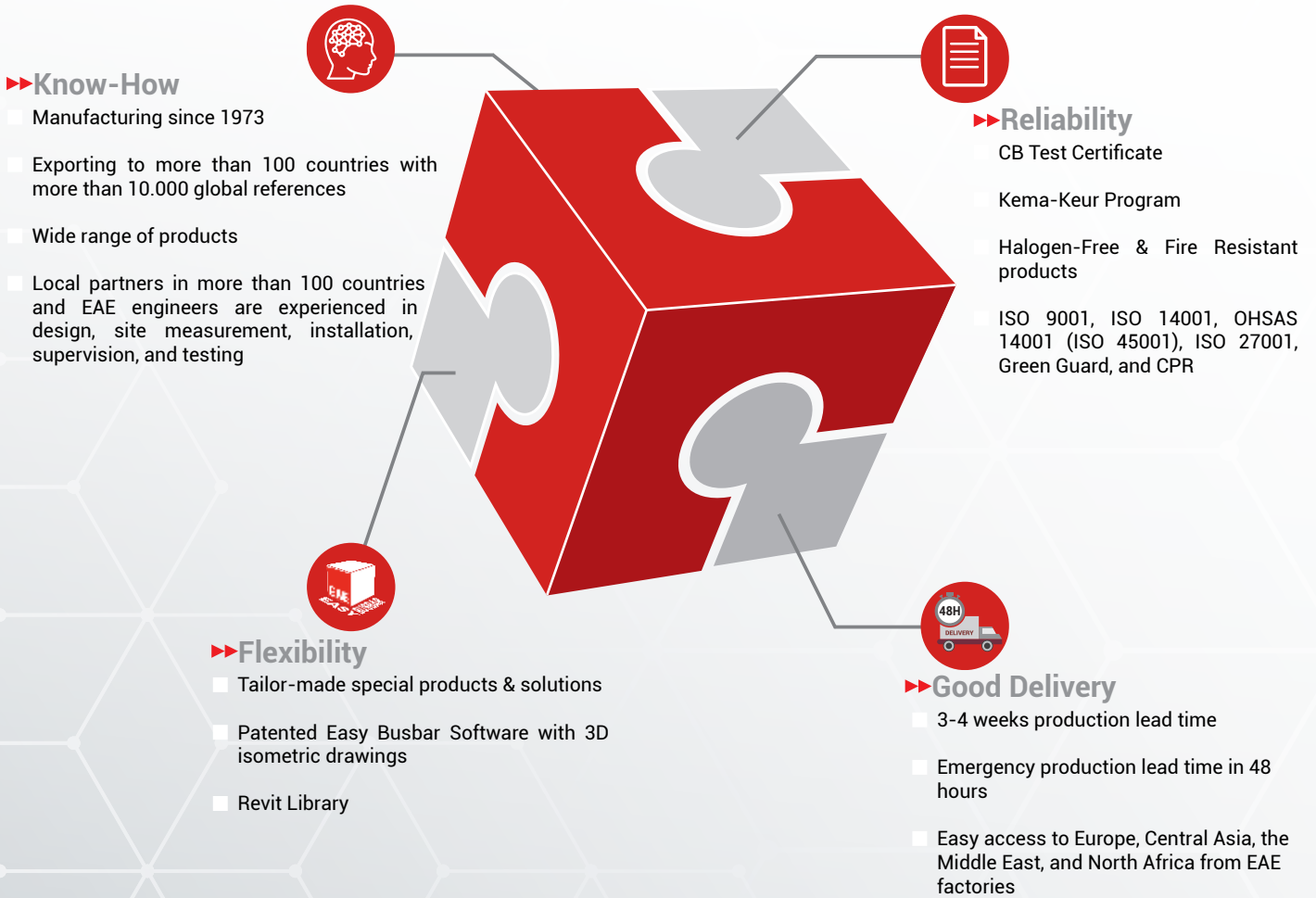



CONTENTS

▶▶ EV CHARGING STATIONS

Why EAE.....	2-6
Applications.....	7
EAE Busbar Products.....	8-10
EAE Busbar Advantages.....	11
EAE Supporting System Products.....	12
EAE Fit-out Products.....	13
EAE Lighting Products.....	14
EAE Enclosure Products.....	15
EAE Lighting Automation Products.....	16
Major References.....	17-18

EV CHARGING STATIONS

Why EAE



▶▶ RELIABLE AND ROBUST SOLUTION WITH BUSBARS

Transportation and distribution of electricity were used to be provided by paralleling several large-sized cables. In order to support these cables in the buildings, there must be a lot of cable trays, cable ladders, under-floor cable channels, etc. Applications of cables, such as, fixing to cable channels, branching, connecting, calculating distances between cables for heat dissipation, adjusting difference lengths, etc. need special expert workers, more time, more effort, which means more money. In order to eliminate all the above disadvantages, modern **BUSBAR SYSTEMS** are developed. **EAE** manufactures **E-LINE** busbar systems from 25A up to 6300A since 1973 in order to convert the above disadvantages to advantages.

- Busbars have a **compact structure**. Compact structure is provided by placing insulated/separated conductors in the housing.
- Busbar systems **do not burn, do not carry flames, and do not generate poisonous (halogen, etc.) gas** in case of fire. Traditional cable systems can burn and enable fire to propagate in the buildings.
- Busbars can be applied to any kind of building by their **modular structure**. Busbar trunking systems have the **advantage of expansion, change, replacement, and re-using capability** in the future. According to the future needs, the design of the busbar system can be changed easily or fully/partially moved to another establishment.
- During the design stage of the building, busbar systems reduce the number of **cable trays, distribution boards, dimensions of main panel boards, MCBs, and MCCBs in panel boards and eliminate all the accessories of cable systems**.
- **Installation time is much shorter** than cable systems. This provides **low installation and workforce costs** and helps for **better time management**.

▶▶ SAFETY

- EAE tap-off boxes are able to feed any brand of wall boxes easily without any additional systems and mechanisms.
- All outgoing cables with suitable plugs are protected by **breakers** equipped in EAE tap-off boxes.
- EAE tap-off boxes are **mechanically and electrically interlocked** with the busway housing to prevent fixing or removal of EAE tap-off boxes while the switch is in the ON position.
- EAE tap-off boxes can be equipped with an **operating handle** that always remains in control of the switching mechanism.
- EAE tap-off boxes are lockable by a **padlock** (only authorized personnel from the maintenance team will be able to operate EAE tap-off boxes).
- It's easy, economic, and safe to get the power from the EAE Busbar line with EAE tap-off boxes where they are needed. The **number of tap-off boxes** can be increased safely on plug-in points and block joints. The **location of these EAE tap-off boxes** can be easily changed according to future needs.
- Busbar systems do not burn, do not carry flames, and do not generate and propagate the poisonous (halogen, etc.) gas in case of fire.
- Busbars can not be bitten and damaged by rats, bugs, etc. because the housing is made of metal.



Bolt-on Tap-off box can be fixed, taken off, or operated after switching off the system by an only authorized person.

EV CHARGING STATIONS

Why EAE



▶▶ TAP-OFF BOX WITH ANY TYPE OF BREAKERS

Plug-in and bolt-on tap-off boxes are a unique technology to drain power up to 1000A at plug-in outlets and/or block joints providing power distribution solutions.

EAE tap-off boxes are compatible with Worldwide brands of circuit breakers and switches.

All-metal enclosure tap-off boxes can be supplied;

- With any type, model, the brand of breakers
- With any gland type or with a blank gland plate
- Any required color of the housing
- Has an electrical interlock mechanism
- Has a mechanical interlock mechanism
- Has IP55 protection degree
- Has tulip contacts made of silver-plated copper
- Can be tailor-made to any size

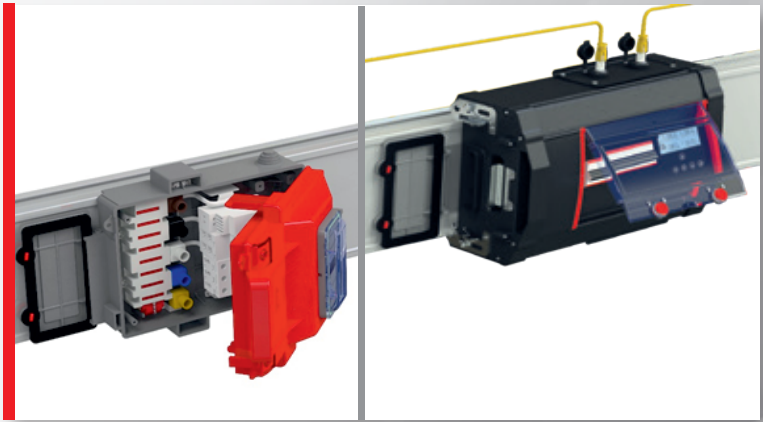

▶▶ COST EFFICIENCY & BETTER VOLTAGE DROP

- EAE busbars systems provide **better voltage drop and short circuit values**, which make the power distribution more reliable and economical than the traditional cable system solutions in buildings.
- Busbars can be applied to any kind of building by their modular structure. Busbar trunking systems have a big advantage due to **thermal expansion, flexibility, route change, replacement, and reusing capability** when it is required.
- **Installation time** is much shorter than cable systems. This provides fewer **manpower costs** and helps for better time management.

During the design stage of the building, busbar systems;

- Reduce the number of **CABLE TRAYS**,
- Reduce the number of **DISTRIBUTION BOARDS**. It is possible to feed loads directly with EAE tap-off boxes,
- Reduce the **DIMENSIONS** of **MAIN PANEL BOARDS**,
- Reduce the number of the **MCBs / MCCBs**,
- Eliminate many **ACCESSORIES** used for cable systems,
- Execute the projects in a shorter time and reduce the **COST**.



EAE E-LINE Busbar Systems



Cable Systems

EV CHARGING STATIONS

Why EAE



▶▶ CANOPY SOLUTIONS

- EAE has its own canopy solution to provide additional protection around the busbars.
- The canopy system also can be manufactured by customers/clients in the coordination of EAE and their architects to maintain visual harmony in facilities/buildings.
- EAE LV power busbars are IP55, besides IP68 LV cast resin busbars are available too. These IP 55 & 65 levels are enough for indoor applications.
- For outdoor applications, IP 68 Cast resin busbar is available with IP 65 tap-off boxes.
- IP67 busbar type is also available for Partially protection with a suitable Canopy in order to protect the busbar systems against human/animal intervention and atmospheric conditions like UV, direct sunlight, rain, and dust.



▶▶ GREEN GUARD CERTIFICATE

- The chemical pollutants come from products and materials that we use at our homes and workspaces like furniture, pieces of equipment, and building materials. These materials emit Volatile Organic Compounds (VOCs) that can negatively affect our health. Since our heating and cooling systems recirculate the same air in all the rooms, that means that VOCs remain inside the buildings, posing problems.
- The Greenguard Environmental Institute is an independent organization that certifies products and materials for low chemical emissions. Products that are certified by Greenguard have to meet stringent standards and emission limits for indoor use like schools, daycares, and other areas. You can rest assured that any product with the Greenguard Gold certification will not emit significant chemical compounds into the air which is scientifically proven to reduce indoor air pollution and the risk of chemical exposure.
- EAE Busbar Systems are certified by Greenguard since 2015.

GREEN GUARD



EV CHARGING STATIONS

Why EAE



►► FIRE RESISTANCE CERTIFICATE

■ Fire Resistance Tests IEC 60331-1 (Circuit Integrity Under Fire for E-LINE KX)

- IEC 60331-1 1000°C - 3 hours - BRE, UK
- IEC 60331-1 950°C - 3 hours - TUV, Singapore
- IEC 60331-1 1000°C - 2 hours - DEKRA, Netherlands
- BS 8491 842°C - 2 hours - BRE, UK
(Sprinkler Water & Mechanical Impact)
- EN 50399 Low Heat and Low Smoke Release
B1/S1 d0 - Dekra, Netherlands

■ Fire Resistance & Circuit Integrity Tests for E-Line KX with Plug-in Tap-Off Box

- IEC 60331-1 830°C - over 3 hours, Magnetic
MCCB - DEKRA, Netherlands
- IEC 60331-1 830°C - over 3 hours, NH Fuses - DEKRA, Netherlands

■ Flame Propagation Test IEC 60332-3 (IEC 61439-6,10.101)

■ Fire Barrier Test - 2 Hours ISO 834-1 (IEC 61439-6,10.102)



►► SEISMIC SUPPORTS

■ EAE Seismic support systems offer perfect solutions for installations for earthquake protection.

■ Seismic supports which can be applied on all kinds of installations ensure easy and quick mounting. Thanks to the accessories designed for steel-beam and space frame connections.



▶▶ RoHS & REACH

- RoHS directives were published and started to implement from 01 July 2006 to all members of this protocol worldwide. This directives goal is to limit some hazardous materials like Pb, Hg, Cd in Electrical and Electronic pieces of equipment. Those materials had a serious impact on human health.
- EAE ELEKTRİK keeps human health and product safety at the highest level to not use detrimental elements that create negative effects on the environment and human health, as stated in the RoHS directives.



▶▶ PAINTED HOUSING FOR BUSBAR SYSTEM (ANY COLORS)

- The housing of any type/model/rating Busbar can be painted in any color selected by the designer/client in order to match the building/room aesthetically.
- Polyester epoxy paint with a min. 75-micron thickness on the housing provides a better strength against environmental conditions.
- Any similar requirement can be applied to our Cable trays as well.
- This process is done in EAE's in-house plant as per QA/ QS procedures in several steps with chemical surface preparation, acidic treatments for degreasing, and applying the necessary coats of paint on the surface of metal sheets.

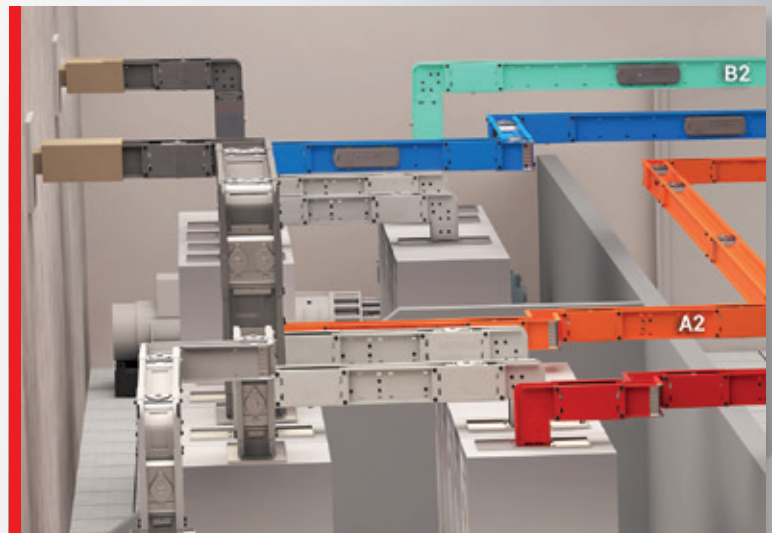

EV CHARGING STATIONS

Applications



▶▶ Outdoor Application with IP68 Busbar

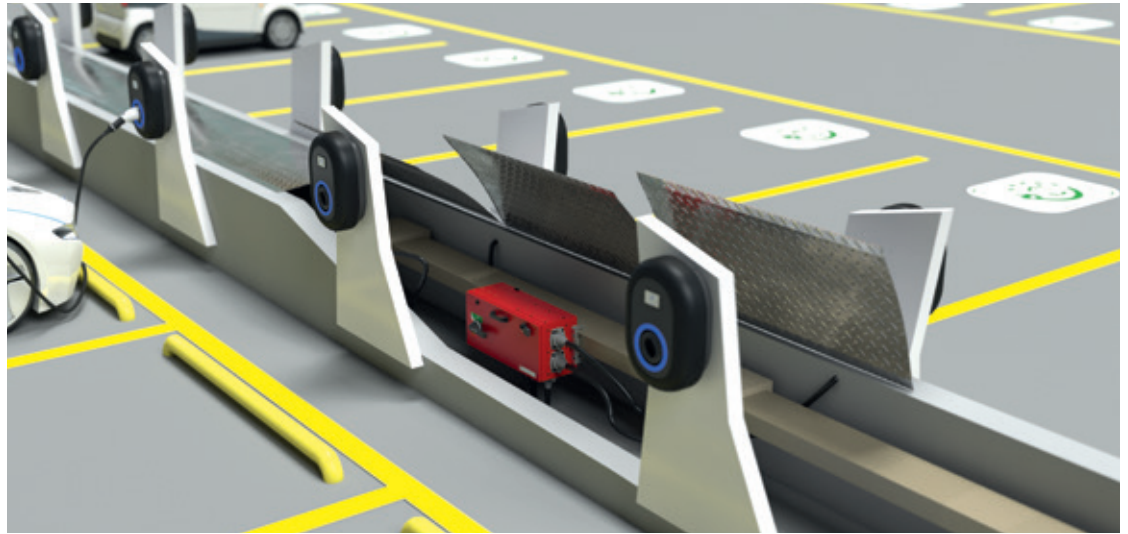

▶▶ Indoor Application with IP55 Busbar (IP65 Busbars are optional)



▶▶ E-LINE KX

Compact Busbar Distribution System 400...6300A

Overview

The EAE E-Line KX Series compact busbar system is designed for use in projects requiring high power distribution and is rated from 400A to 6300A using the latest technology.



Features:

- UL 857 and IEC 61439-1&6 product
- Modular structure
- Ability to supply energy either from the joints or from the tap-off points (Bolt-on or Plug-in)
- High electrical and mechanical strength
- Fast, easy and reliable installation with single bolt joint construction.
- Output units allow a significant saving about panel and system cost
- Special design for minimal voltage drop
- Tin-plated (optional silver plated) aluminum or copper conductors
- IP 55 and IP 65 standard, IP 67 optional protection degree
- Aluminium housing
- Epoxy insulation
- Fire resistance as per IEC 60331

▶▶ E-LINE CR

Compact Busbar Distribution System 630...6300A

Overview

The body of the E-Line CR busbar is formed using DURACOMP, a composite material of epoxy resin and pure silicon which gives protection against arduous environments and high impact.

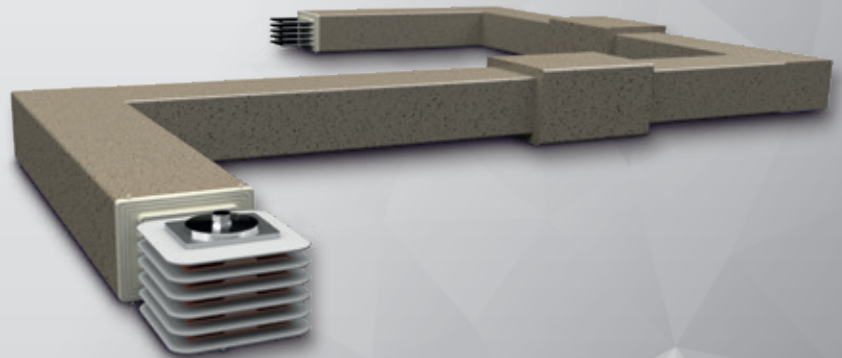

Features:

- IEC 61439-1&6 product
- Current Aluminium and Copper ranges from 630A to 6300A
- IP68 / IP69 K protection degree
- 4, 5 and 6 conductor options
- Clean earth option
- IEC 60331-1, 3 hours of continuous current under fire condition
- Conformance to seismic requirements in accordance with IEC 60068-3-3; IEC 60068- 2-57 and IEEE 693 standards

▶▶ E-LINE KO-II

Busbar Distribution System 160...800A

Overview

"E-Line KO Series" medium-range busbar systems provide suitable solutions for electricity transmission and distribution in medium-sized project facilities.

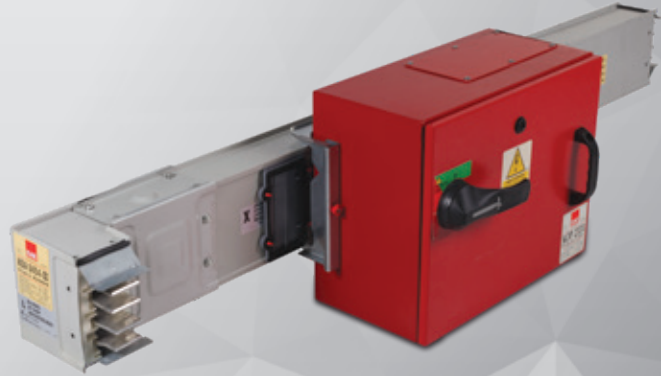

Features:

- IEC 61439-1&6 product
- Modular structure
- Plug-in tap-off outlets at every 25 cm
- Aluminium or copper conductors
- 4, 4,5, or 5 conductors
- Tin plated conductors
- Dust cover on outlet points
- IP 55 protection class

▶▶ E-LINE MK

Busbar Distribution System 100-160-225A

Overview

The small power range busbar systems of "E-Line MK Series" provide flexible and cost-effective solutions for the transmission and distribution of electricity in small-sized enterprises, workshops, and industrial facilities.



Features:

- IEC 61439-1&6 product
- Modular structure
- Plug-in tap-off outlets at every 25 cm on both sides
- Tin-plated aluminum or copper conductors
- 4 or 5 conductors
- Hinged and lockable dust cover on outlet points
- Installation without using a torque wrench (shear head bolts)
- IP 55 protection class
- Flexible elbows and expansion modules

▶▶ E-LINE DL/SL

Multi-conductor Lighting Busbar Systems 25-32-40A

Overview

The E-Line DL/SL range of busbar systems are used in buildings on lighting and socket circuits where 25A, 32A, or 40A Three-phase or Single-phase power is required.

10-16A plugs or 25A tap-off boxes with a cartridge fuse or miniature circuit breaker are specially designed to supply lighting and power circuits as per the specifications.

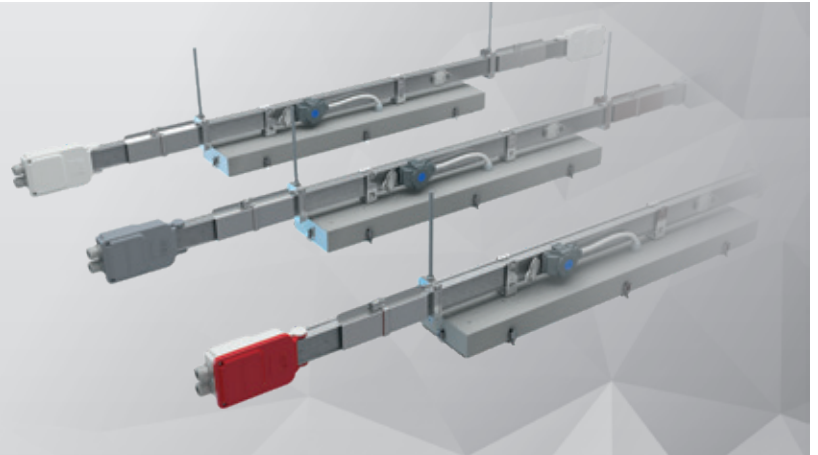

Features:

- IEC 61439-1&6 product
- Choice of conductor configurations up to 10 conductors with 5+5 form
- Tap-off plugs are available in different colors to indicate the phases
- Strong body structure which can support all types of luminaires
- IP 55 protection class
- Clean Earth "CE" conductor for UPS circuit
- The Emergency Kit (ACK) supply and the Dali signal are fed through the same busbar and tap-off plugs negating the need for extra cabling.

▶▶ E-LINE KY

Lighting & Low Power Distribution System 25-40-63A

Overview

KY Busbar System is suitable for all kinds of lighting, sockets, and low power circuits with 25-40-63A current levels. Also within the scope of lighting automation, DALI and DIM circuits can be used to transmit the emergency lighting kit reference voltage.

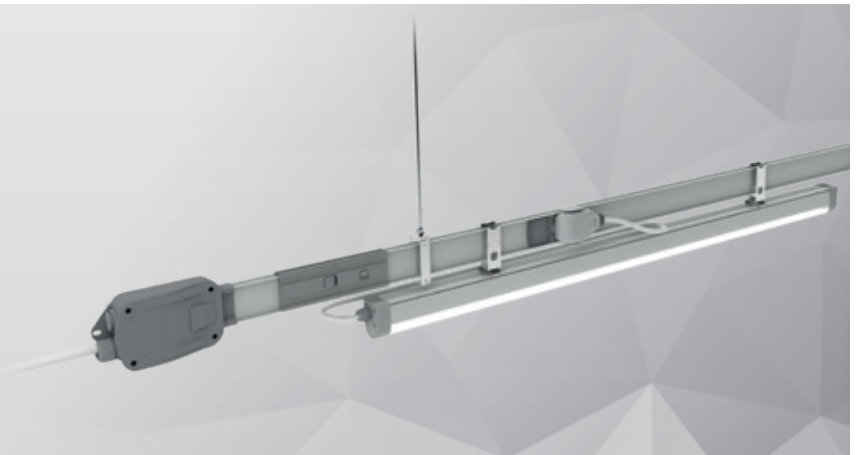

Features:

- IEC 61439-1&6 product
- 3 and 4 meters standard busbar length, plug-in points every 1 meter,
- At all joint and plug-in points, the contacts are plated with silver,
- Copper conductors are covered with full-length tin and copper oxide formation is prevented,
- Simple joint structure that prevents deflection and stretching.

EV CHARGING STATIONS

EAE Busbar Advantages



Electrical power distribution is vital for any building. The distribution products need to be selected carefully in order to obtain the safest, reliable, and long-lasting system

DEKRA Certified by DEKRA laboratory in Netherlands required 25 type test for every model, rating of busbars

CB CB certificate to ensure the product has been tested for all required type tests

GREENGUARD Greenguard certified in order to use in hygienic environments

IEC Designed and manufactured as per IEC 61439-1 & 6 standards

IP Standard IP55 and can be manufactured IP65, IP67, and IP68 ingress protection level

Integrating to building management systems by smart communication that can be equipped with EAE's tap-off units at any place of the power busbar system

Safe to get power from busbars for the transformer to LV & MV switchgear, switchgear cabinets to switchgear, vertical & horizontal applications to feed other floors, rooms, pieces of equipment, and lights

Can be expanded from the end of any installed busbar line without any modification on the existing power system because all power busbar types can be fixed each other

Over 50 years of continuous manufacturing in busbar systems

1 **2**

3 **4**

5 **6**

7 **8**

9 **10**

11 **12**

KEMA-KEUR certificate in order to have continuous manufacturing monitoring program by DEKRA

UL certification as it is the leading globally recognized testing authority in the U.S.

Busbar system substantially reduces the risk of fire and fire propagation due to metal encapsulation proven by international certificates, 15-20% less fire load than cable

EAE Seismic support systems offer perfect solutions of installations for earthquake conditions with necessary steel-beam, bracing and space frame supports

Busbar metal housing provides long life service due to their robust structure

Flexibility in enabling the provisional connection by tap-off units to get power easily those can be equipped with any brand of breakers

Very easy to install the Busbar modules in a short time by saving time & money thanks to the simple type of block joints

Services by dealers with all required services from design, supervision, and testing

▶▶ E-LINE A-A

Supporting Systems & Accessories

Overview

E-LINE A-A series and E-Line Seismic suspension systems are used in buildings and factories; in concrete or steel structures to carry Busbar, Conduit, Cable Ladder, etc. Systems appropriately. Service- and light service-type suspension types diversities are available according to the weight of the system to be carried.



▶ A-A SUPPORT SYSTEMS

Hot Dip Galvanized (TS EN ISO 1461), Fire Resistant (E30-E90)

E-Line A-A series of support systems are designed for heavy-duty loads. The A-A series can be produced from 2.0mm up to 4 mm. as below available finishes. With its special coating, it can provide project required corrosion protection and it is fire resistant.



▶ STRUT CHANNEL (G PROFILE)

Pre-galvanized (TS EN 10346 - TS EN 10143), Hot Dip Galvanized (TS EN ISO 1461), and Stainless Steel

E-Line STRUT CHANNEL series is a modular support system specially designed for heavy-duty loads with its numerous assembly variations. The BINRAK series can be produced with 1.5, 2.0mm, and 2.5mm thickness as pre-galvanized and hot-dip galvanized and stainless steel.



▶ SEISMIC

Hot Dip Galvanized (TS EN ISO 1461)

E-Line Seismic bracing assembly systems are designed to secure the support systems sustainability against seismic waves with lateral and longitudinal applications withstanding the push and pulling forces. The assemblies are produced as hot-dip galvanized with electro galvanized accessories.



▶ M-FIX ELECTRO-MECHANICAL SUPPORT AND SUSPENSION SYSTEMS

Pre-galvanized (TS EN 10346 - TS EN 10143) and Hot Dip Galvanized (TS EN ISO 1461)

- Pre-galvanized and Hot-Dipping alternatives
- Suspension system varieties of Light, Medium, and Heavy-Duty type
- Coating resistant to the salt test of 400 hours for the purpose of corrosion prevention of products such as Stem Bar, Bolt, and Nuts of switch material fittings
- Mechanical suspension solutions specific to customer requirements.



►► FIT-OUT SOLUTIONS

It provides flexible and modular solutions with socket circuits for small power distribution in offices and plants.

Overview

Stylish, safe, and innovative design, modular and compact solutions. The underfloor and raised floor power distribution systems save office etc environments from cable stacks and offer streamlined cabling. Can be adapted when offices or workplaces are moved around or capacity increases.

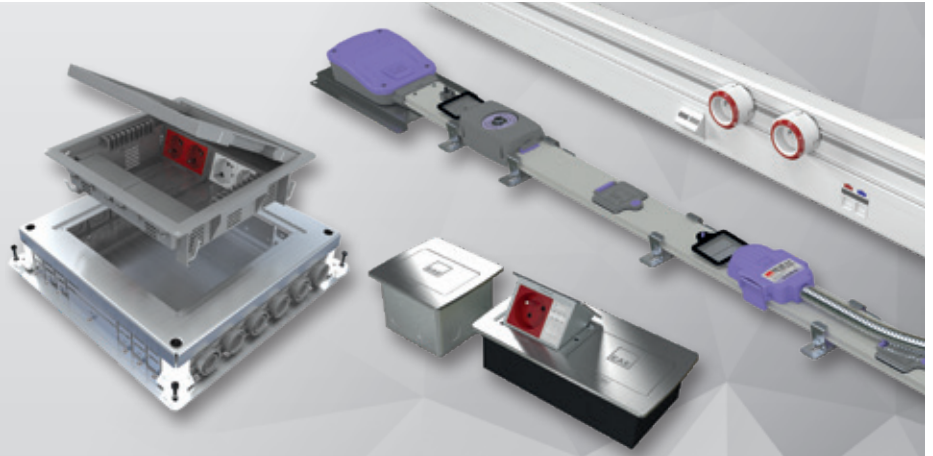

► E-LINE FL/FLD

Indoor Busbar Trunking Systems 32A

Stylish, safe, and functional busbar trunking system eliminating cable stacks. Offers solutions for structural cabling such as mains, UPS, data, phones, etc. through surface-mounted skirting or at table level environments at offices, technology markets, stores, hospitals, or workshops. Offers power transfer without the need for additional cable, easily and safely from any point.

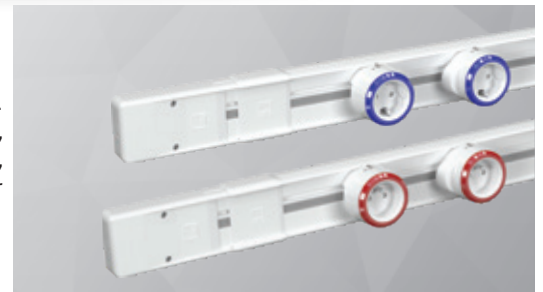

► DABLINE

Raised Floor Power Distribution Systems 63-80A

DABLINE busbar systems, which have different color options, are used for raised floor applications in offices.

Does not require a cable duct, cable, junction, or connector. Manufactured in either 63A or 80A current rated versions with the tap-off plugs rated 13A to 32A.

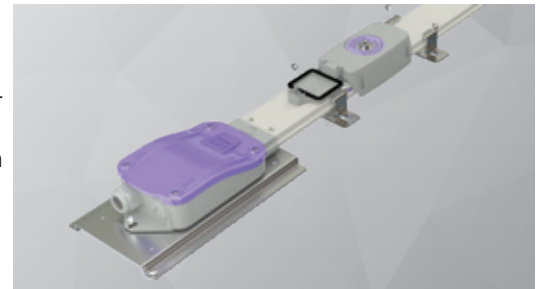

► E-LINE N-DK / E-LINE MINI

Modular and Compact Solutions for Underfloor and Raised Floor / Mini-Series Pop-up and IP66 Outlet Boxes

Stylish, safe, and innovative design, modular and compact solutions.

The underfloor and raised floor power distribution systems save office etc environments from cable stacks and offer streamlined cabling. Can be adapted when offices or workplaces are moved around or capacity increases.

New, aesthetic, compact, and mini-solutions for working desks, raised floor, and under-screed sockets. Three different ranges with IP40 and IP66 options.

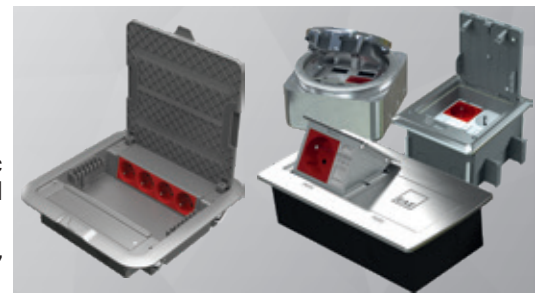

► E-LINE MULTIBOX

Socket Combination and MCB Boxes

E-Line MULTIBOX equipped and/or empty socket combination and fuse (distribution) box solutions for factories, construction sites, workshops, and working environments.



EV CHARGING STATIONS

EAE Lighting Products



▶▶ PARKING SOLUTIONS

Parking lots are one of the most preferred areas of use in daily life. Sufficient and properly illuminated car parks offer drivers safe and easy parking. Therefore, choosing suitable fixtures for parking areas will provide high comfort and efficiency in the long run. In general, waterproof luminaires are preferred for parking lot lighting. Meeting with LEDs in the lighting of parking lots will save up to 60% in expense and energy consumption. In this sense, the selection of luminaires that match the parking lot lighting criteria will also bring sustainability. In addition, the use of sensors and smart systems in car parks that are frequently used at short intervals will greatly reduce operating expenses. LED lighting fixtures developed by EAE will provide maximum illumination with minimum energy consumption for many years when integrated with control systems. In addition, more homogeneous, low-cost, and energy-saving can be achieved by using advanced optical lens options. With the "BATWING" lens option we have developed for indoor parking projects as EAE lighting, additional 50% cost savings are achieved in parking lots compared to conventional LED products. Integrated and efficient projects are designed with Busbar, LED lighting, and automation systems developed by EAE group companies.



▶ INDOOR PARKING AREAS

Indoor parking areas can create adverse conditions for drivers when they are not illuminated in accordance with the field conditions. Ensuring adequate lighting conditions in parking garages is very important for creating a safe parking space and for a comfortable driving experience. While 75lux illumination level is sufficient for indoor parking areas and the other parts, 250-300lux illumination level will be sufficient for entrances and exits. In areas with high dust and humidity, choosing LED Waterproof luminaires with IP65 protection class will be the right choice for parking garages that cannot benefit from daylight.

LINE ETANJ



LINE ETANJ MINI V.2



COZAR



▶ OUTDOOR PARKING AREAS

Outdoor car park lighting should be completely tailored to the needs of the drivers. The lighting level to be used in this area between 10-20lux will be sufficient. In outdoor parking lots, the main preferred lighting is street luminaires and floodlights. In this way, it will facilitate the homogeneous spread of light. While pole lighting is suitable for small car parks, high-performance projectors are used in outdoor car parks with large areas. Preferring luminaires with low glare values in outdoor car parks is closely related to the visual comfort of the drivers.

PROLIT



PROLIT PLUS



RA



RA 2



PB - V2



EV CHARGING STATIONS

EAE Enclosure Products

▶▶ PANELMASTER

Type-tested LV Switchgears Up to 6800A

PanelMaster low voltage switchboards are designed to fulfill various application needs. Its unique structure and flexible power modules are type-tested and certified by internationally accepted independent laboratories.

PanelMaster has been type-tested with switchgear equipment of various suppliers. This gives freedom at component selection among widely accepted and known switchgear equipment brands.



Rated Current (I_n)	: Up to 6800A
Rated Short Time Withstand Current (I_{cw})	: Up to 120 kA - 1sec.
Rated Impulse Withstand Voltage (U_{imp})	: Up to 12 kV
Partitioning	: Up to Form 4b
Protection Class	: Up to IP55
Protection Class Against Mechanical Impact	: IK10
Framework	: Painted 2mm pre-galvanized steel
Colour	: RAL 7035 epoxy-polyester electrostatic powder paint

▶▶ E-Kabin

Type Tested Empty Electrical Enclosures

E-Kabin brand type-tested according to IEC 62208, offers complete solutions for low voltage empty electrical enclosures in various applications.

- Wall Mounted Enclosures (E-Kabin M, O, E Series)
- Stand Alone Enclosures (E-Kabin S, D Series)
- Outdoor Enclosures (E-Kabin H Series)
- Stainless Steel Enclosures (E-Kabin X Series)
- Terminal Boxes (E-Kabin T Series)
- Consoles (E-Kabin K Series)
- Type-tested Busbar Supports (E-Kabin B Series)



▶▶ EAE Technology Parking Area Solution

EAE KNX Lighting Control Solution

EAE's KNX Lighting Control Solution is flexible and extendable to fulfill all the requirements and expectations of projects. EAE Technology's KNX products are designed with manufacturer-independent protocols such as KNX, making extensions of the system possible with any other KNX manufactured products.

KNX Corridor Sensor



KNX Presence Sensor



KNX Movement Sensor



KNX High Bay Motion Detector



KNX Push Button Interface



KNX Switching Actuators



KNX-DALI Gateways



Lighting Control

- DALI
- On/Off
- 1-10V
- Universal DIM (phase cut)
- Emergency Lighting Reporting



Presence / Movement / Corridor & Daylight Sensor

EAE DALI-2 Lighting Control Solution

DALI-2 refers to the latest version of the DALI protocol. Compared with DALI version-1, there are many new commands and features in DALI-2. While DALI version-1 only included control gear, DALI-2 has control devices such as application controllers and input devices (e.g. sensors), as well as bus power supplies.

DALI-2 Corridor Sensor



EAE DALI-2 Presence Sensor



EAE DALI-2 Movement Sensor



EAE DALI-2 High Bay Motion Detector



EAE DALI-2 Push Button Interface



EAE DALI-2 Oria Switch



EAE DALI-2 DA-STx Rosa Switch Series



EV CHARGING STATIONS

Major References

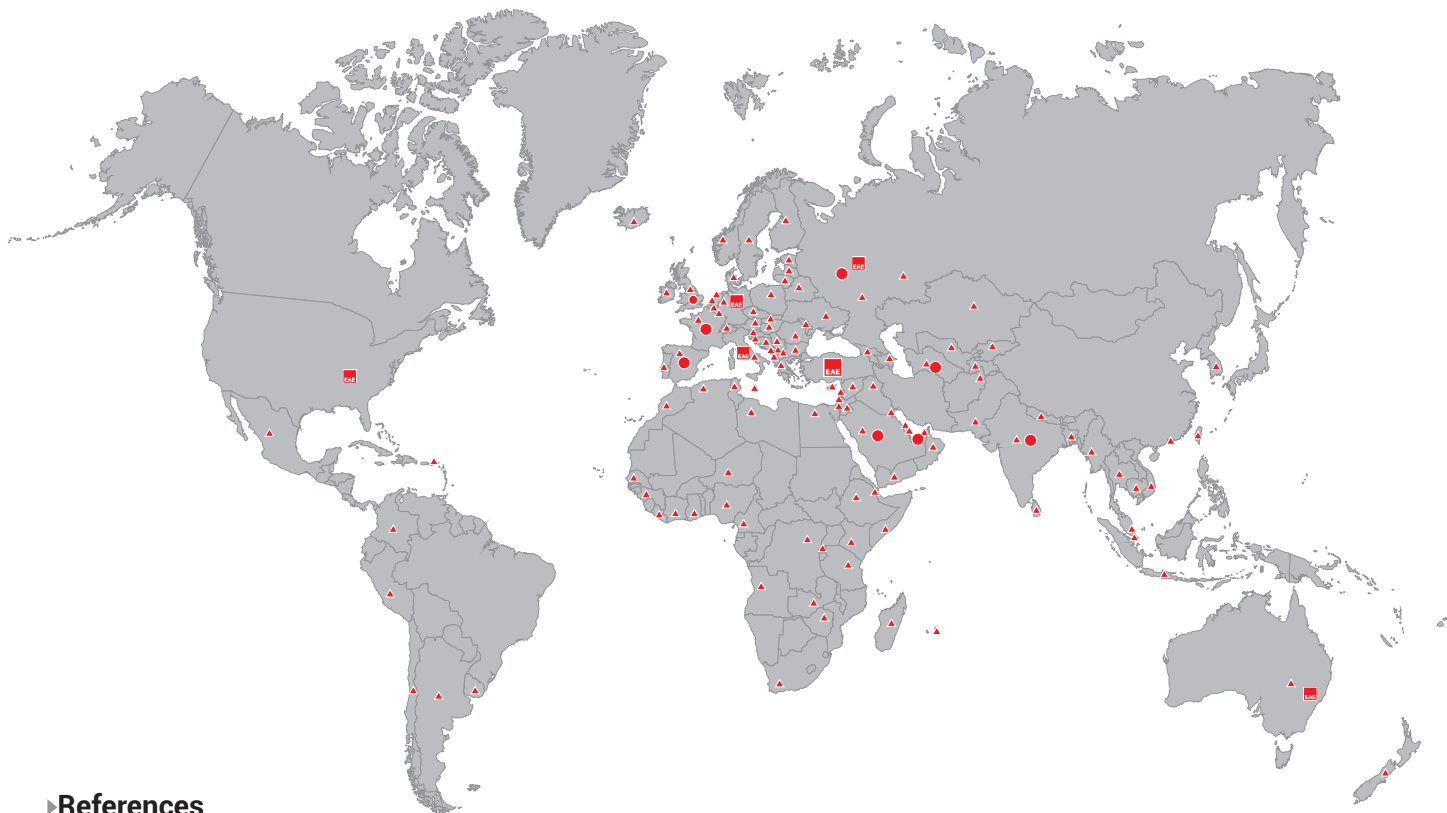

►References

VBZ - Zurich Public Transport	Zurich, Switzerland
IKEA	Switzerland
Essen RWE Campus E-Ladepunkte	Essen, Germany
Köln DIBAG Parkhaus 1	Köln, Germany
Köln DIBAG Parkhaus 2	Köln, Germany
Essen Aldi Parkhaus 1	Essen, Germany
Essen Aldi Parkhaus 2	Essen, Germany
Essen ALDI Nord Campus	Essen, Germany
München Parkhaus Zenith	München, Germany
München SWM TG und Kita	München, Germany
Berlin QBB-B Ladestationen	Berlin, Germany
Luxemburg Auvent 2+3	Luxemburg
Stuttgart SW9 NB Verwaltungsgebäude UG	Stuttgart, Germany
Düsseldorf Eclipse mit E-Ladepunkte	Düsseldorf, Germany
OSL Gardermoen Airport Parking	Oslo, Norway
OSL Gardermoen Airport Hertz Rental	Oslo, Norway
Tomtebygga B1 apartments and Hotel	Oslo, Norway
Professor Birkelands vei	Oslo, Norway
Grønn Kontakt EV Entrepreneur	Norway
Porsche EV Supercharger Billingstad	Norway
TSG Group Charging Stations	France
Etelärannan Huolto Oy	Finland
As. Oy Rettiginrinne	Finland
As. Oy Tuhtopolku	Finland
Tyyrpuuri	Finland
Pan Ledi Pancevo	Serbia
Brederode Offices	Brussels, Belgium
Parking Grognon	Namur, Belgium
INFINITY Shopping Center	Luxembourg
Garage ASML	Veldhoven, Netherlands
Garage Atrium	Amsterdam, Netherlands

EV CHARGING STATIONS

Major References



► Projects



ALDI Nord Campus
GERMANY



Essen RWE Campus
GERMANY



Köln Parkhaus
GERMANY



IKEA
SWITZERLAND

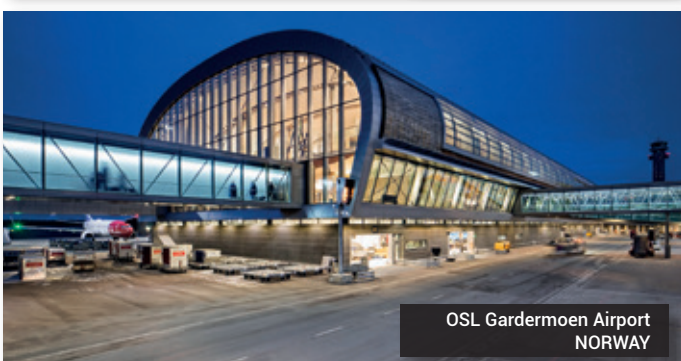

OSL Gardermoen Airport
NORWAY

► Applications



EAE GROUP COMPANIES PRODUCTS/SOLUTIONS

**BUSBAR ENERGY DISTRIBUTION SYSTEMS &
CABLE MANAGEMENT SYSTEMS &
FIT-OUT SOLUTIONS**



LIGHTING SOLUTIONS



LIGHTING AUTOMATION



**PANELMASTER ENCLOSURES /
PANELMASTER SYSTEMS**



Please visit our website for the updated version of our catalogs.
www.eaegroup.com



EAE Elektrik A.S.
Head Office
Akcaburgaz Mahallesi,
3114. Sokak, No:10 34522
Esenyurt - Istanbul - TURKEY
Tel: +90 (212) 866 20 00
Fax: +90 (212) 886 24 20

EAE DL 1 Factory
Cable Tray
Makine Ihtisas Organize Sanayi
Bolgesi Mahallesi, 6. Cadde,
8. Sokak, No:6 41455
Dilovası - Kocaeli - TURKEY
Tel: +90 (262) 502 05 65
Fax: +90 (262) 502 05 70

EAE DL 2 Factory
Lighting - Electrotechnical
Makine Ihtisas Organize Sanayi
Bolgesi Mahallesi,
1. Cadde, No:4 41455
Dilovası - Kocaeli - TURKEY
Tel: +90 (262) 999 05 20
Fax: +90 (212) 549 37 90

EAE DL 3 Factory
Busbar
Makine Ihtisas Organize Sanayi
Bolgesi Mahallesi, 6. Cadde,
8. Sokak, No:6 41455
Dilovası - Kocaeli - TURKEY
Tel: +90 (262) 502 05 65
Fax: +90 (262) 502 05 70

info@eaegroup.com



IEC 61439-6



Catalog 70-Eng. / Rev 01 / 1.000 Pcs. 03/07/2023
G.M.

EAE has full right to make any revisions or changes on this catalog without any prior notice.

